

BANNER[®]
more sensors, more solutions



Wireless Products





Contents

Sensors, Lighting and Indicators	5
Temperature & Humidity	6
Vibration & Temperature	10
Ultrasonic Sensor	12
Photoelectric Q45	14
Q45 1-Wire Serial	16
Q45 Switches and Push Buttons	18
6-Button Pendant	20
Wireless Tower Light	22
Wireless Indicator	26
Wireless Touch Button	28
Controllers	31
DXM100	32
DXM150	34
Industrial Wireless Radios	37
PM Series	38
Serial Data Radios	42
Ethernet Data Radios	44
Performance Series-Gateways	48
Performance Series-Nodes	50
MultiHop Modbus Radios	58
Intrinsically Safe Nodes	66
Accessories	69
Reference	86
How to Reach Us	89

Powerful
Capabilities

Sophisticated
Functionality

Engineered
Simplicity



Reliable

Good signal strength assures uninterrupted communication. Banner offers an integrated site survey capability to evaluate and ensure good radio signal strength prior to installation.



Scalable

Banner wireless networks grow with your needs. Simple wire replacement products are preconfigured to support up to six Nodes and can be expanded to accommodate as many as 47 Nodes using the configuration software.





Long Range

Designed for long distance applications, Banner wireless networks are capable of up to six miles of line-of-sight coverage, making them an ideal solution for applications in remote and difficult to access locations or where running wire or conduit is impractical or too expensive.



Easy-to-Use

Banner's Simple Wire Replacement product line provides flexible networks that are easy to set up without software. Setting up a basic point-to-point network is as easy as pairing a cell phone to a headset.



Secure

Binding radio Nodes in a network locks them to a specific Gateway. After the devices are bound, each Gateway only accepts data from the Nodes that are bound to it.





Sensors, Lighting and Indicators

Wireless sensors, lighting, and indicators allow you to remotely monitor and diagnose systems quickly, which reduces downtime, increases productivity, and provides data to optimize your operation. They are easy to install and set up, eliminate expensive cable runs, and can integrate machines that were not previously network capable.

Temperature and Humidity Sensor



M12FTH4Q and M12FT4Q



A simple way to verify conditions in locations that were once too difficult to access via traditional monitoring methods. With no software required, you can replace cables and extend the range of temperature and humidity signals with minimal effort.

Key Features:

- Achieves temperature accuracy of ± 0.3 °C and humidity accuracy of $\pm 2\%$ relative humidity
- Temperature and relative humidity sensing elements housed in a robust metal housing
- Traceable to NIST standards
- Temperature and Humidity or Temperature-only Sensor to choose from
- Each sensor comes with a Certificate of Factory Calibration
- Reduces labor costs by obviating manual checks and reducing error

Simple Wire Replacement

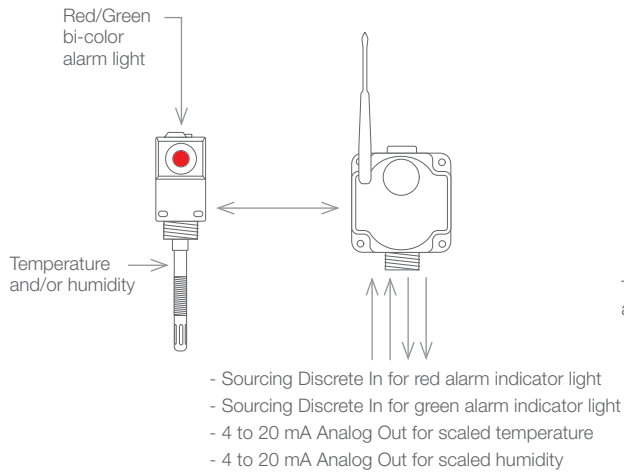

Host Controlled via Modbus RTU (up to 47 Nodes)

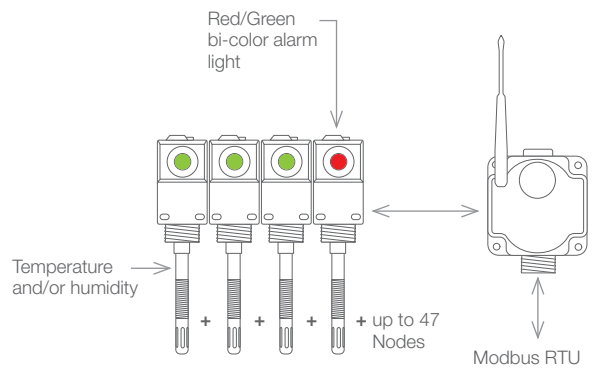

Models	Description
M12FTH4Q	Temperature and relative humidity via a 1-wire Serial Interface
M12FT4Q	Temperature via a 1-wire Serial Interface
Use with	
DX80N9Q45TH	Q45 Temperature/Humidity Node with integrated batteries
DX80N2Q45TH	
DX80N9Q45U	Q45 Universal Node with integrated batteries
DX80N2Q45U	
DX80N9X1S-P6	1-wire Serial Performance Node with integrated battery
DX80N2X1S-P6	
DX80N9X6S-P6	1-wire Serial Performance Node
DX80N2X6S-P6	
DX80DR9M-H6	1-wire Serial Modbus MultiHop Slave with integrated battery
DX80DR2M-H6	

M12FTH4Q and M12FT4 Specifications

Supply Voltage	3.6 to 5.5 V dc	
Current	Default sensing: 28 μ Amps Disabled sensing: 15 μ Amps Active comms: 4.7 mA	
Mounting Threads	M12 x 1	
Indicators	Green flashing: Power ON	Red flicker: Serial Tx
Communication Hardware	Interface: 1-wire Serial Interface Baud rates: 9.6k, 19.2k (default), or 38.4k	Data format: 8 data bits, no parity (default), 1 stop bit (even or odd parity available)
Communication Protocol	Sure Cross [®] DX80 Sensor Node 1-wire Serial Interface	
Communications Line	Level Receive ON: Greater than 2 V Level Receive OFF: Less than 0.7 V	Level Transmit ON: 2.7 to 3 V Level Transmit OFF: 0 V (pulldown resistor of 10 kOhm)
Humidity	Measuring Range: 0 to 100% relative humidity Resolution: 0.1% relative humidity Accuracy: \pm 2% relative humidity at 25 $^{\circ}$ C NOTE: Humidity measurements are only available with the M12FTH4Q model. The M12FT4Q model does not include the humidity sensor.	
Temperature	Measuring Range: -40 to +85 $^{\circ}$ C (-40 to +185 $^{\circ}$ F) ² Resolution: 0.1 $^{\circ}$ C Accuracy: \pm 0.3 $^{\circ}$ C at 25 $^{\circ}$ C	
Environmental Rating	NEMA 6, IEC IP67	
Operating Conditions	-40 to 85 $^{\circ}$ C (-40 to 185 $^{\circ}$ F)	
Shock and Vibration	IEC 68-2-6 and IEC 68-2-27 Shock: 30g, 11 millisecond half sine wave, 18 shocks Vibration: 0.5 mm p-p, 10 to 60 Hz	

Temperature and Humidity Sensor

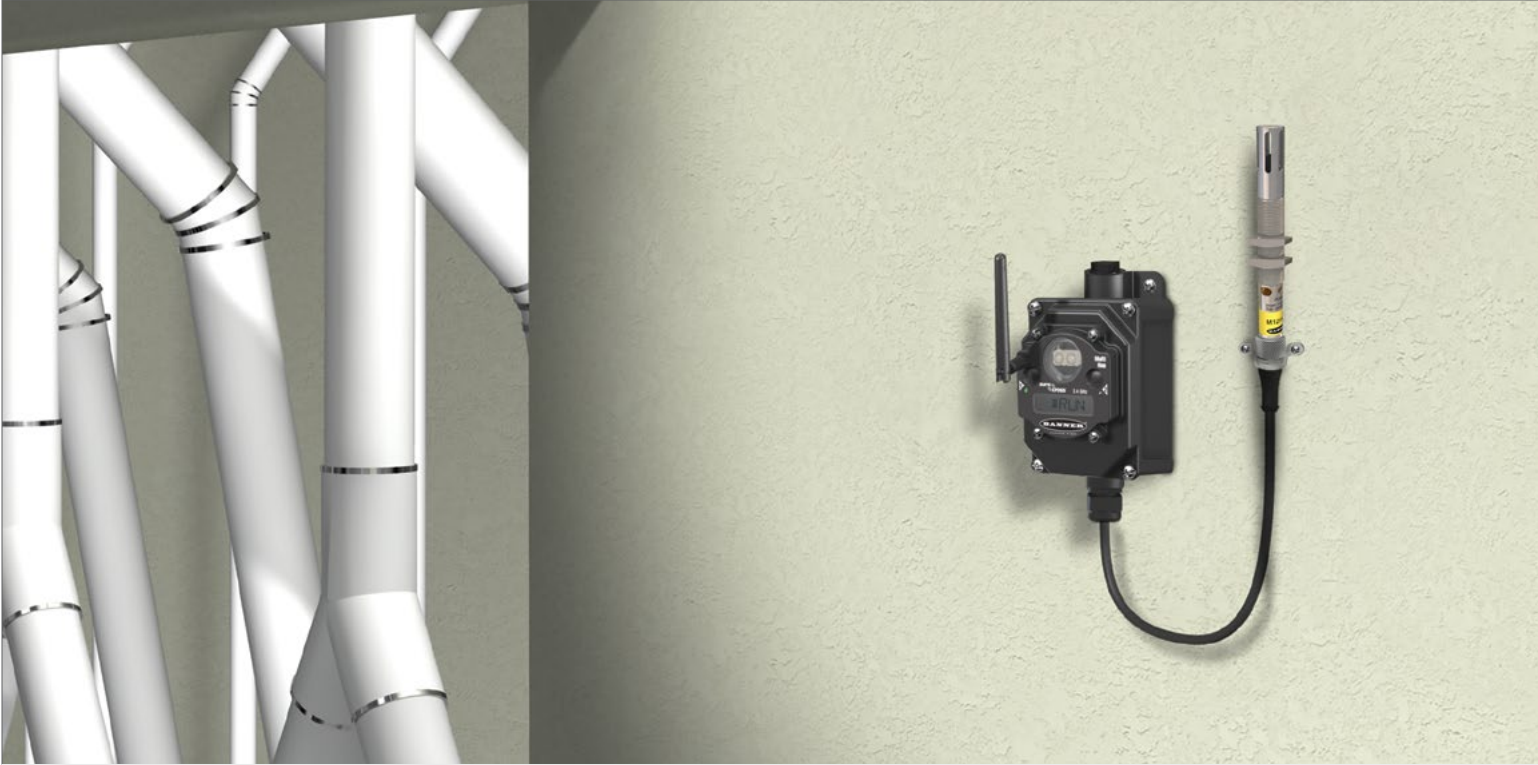

M12FTH3Q and M12FT3Q

This temperature and humidity solution works in a variety of environments to wirelessly provide temperature and humidity measurements via Modbus RTU, RS-485.

Key Features:

- Achieves humidity accuracy of $\pm 2\%$ relative humidity and temperature accuracy of ± 0.3 °C
- Manufactured with a robust metal housing
- Traceable to NIST standards
- Functions as a Modbus slave device via RS-485

Models	Description
M12FTH3Q	Temperature and humidity sensor with Modbus RTU, RS-485 Interface
M12FT3Q	Temperature sensor with Modbus RTU, RS-485 Interface

Used with

DX80DR9M-H1	Inputs: Four discrete, two 0 – 20 mA analog, one thermistor, one counter Outputs: Two NMOS discrete Switch Power Outputs: Two Serial Interface: RS-485	
DX80DR2M-H1		
DX80DR9M-H1E		
DX80DR2M-H1E		
DX80DR9M-H2	Inputs: Four discrete, two 0-20 mA analog Outputs: Four sourcing discrete, two 0-20 mA analog Serial Interface: RS-485	see page 58
DX80DR2M-H2		
DX80DR9M-HB1	Inputs: Two NPN discrete, two 0-20 mA analog Outputs: Two NMOS discrete Switch Power Outputs: Two	
DX80DR2M-HB1		
DX80DR9M-HB2	Inputs: Two PNP discrete, two 0-20 mA analog Outputs: Two PNP discrete, two 0-20 mA analog	
DX80DR2M-HB2		
DX80SR9M-H	Serial Interface: RS-232, RS-485	
DX80SR2M-H		

M12FTH3Q and M12FT3Q Sensors Specifications

Supply Voltage	12 to 24 V dc or 3.6 to 5.5 V dc low power option	
Current	Default sensing: 45 μ Amps Disabled sensing: 32 μ Amps Active comms: 4 mA	
Mounting Threads	M12 x 1	
Indicators	Green flashing: Power ON	Red flicker: Serial Tx
Communication Hardware	Interface: RS-485 Serial Baud rates: 9.6k, 19.2k (default), or 38.4k	Data format: 8 data bits, no parity (default), 1 stop bit (even or odd parity available)
Communication Protocol	Modbus RTU	
Humidity	Measuring Range: 0 to 100% relative humidity Resolution: 0.1% relative humidity Accuracy: \pm 2% relative humidity at 25 °C NOTE: Humidity measurements are only available with the M12FTH3Q model. The M12FT3Q model does not include the humidity sensor.	
Temperature	Measuring Range: -40 to +85 °C (-40 to +185 °F) ² Resolution: 0.1 °C Accuracy: \pm 0.3 °C at 25 °C	
Environmental Rating	NEMA 6, IEC IP67	
Operating Conditions	-40 to 85 °C (-40 to 185 °F)	
Shock and Vibration	IEC 68-2-6 and IEC 68-2-27 Shock: 30g, 11 millisecond half sine wave, 18 shocks Vibration: 0.5 mm p-p, 10 to 60 Hz	

Vibration and Temperature Sensor

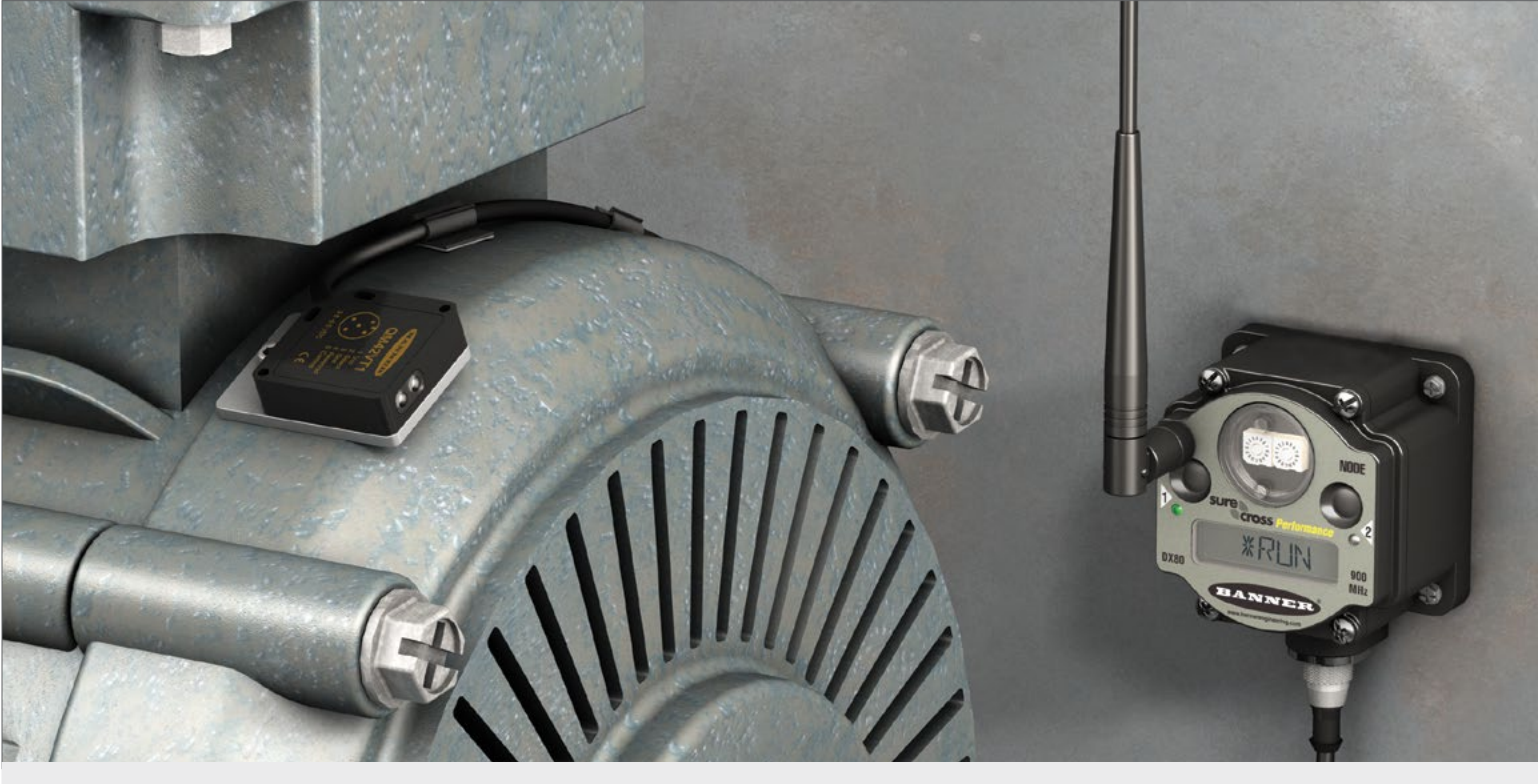

QM42VT



The QM42VT Vibration and Temperature Sensor makes it easy to monitor a machine's health. It measures RMS velocity (among other vibration characteristics) and temperature so that problems can be detected before they become too severe and cause additional damage or result in unplanned downtime. Paired with a Banner wireless Node, it can provide local indication, wirelessly send the signal to a central location, and send the vibration and temperature data to the Gateway for collection and trending.

Key Features:

- Easily monitor machine health by sending info wirelessly to wherever you need it
- Avoid machine failures and delays by detecting problems early
- Reduce downtime and plan maintenance more efficiently
- Monitor a variety of machines to suit your needs

- Motors
- Pumps
- Compressors
- Fans
- Blowers
- Gear Boxes

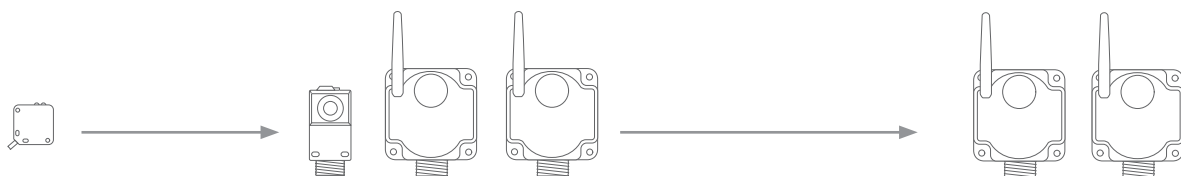

Select Node: one sensor per Node

Select Gateway:
(up to 47 sensors/Nodes) or Data Radio (up to 50+ sensors/Nodes per Master Radio)

Model	Description	
QM42VT1	Vibration and temperature via a 1-wire Serial Interface	
QM42VT2	Vibration and temperature that functions as a modbus slave device via RS-485	
QM42VT1 — Use with		
DX80N9Q45VT	Q45 Vibration/Temperature Node with integrated batteries	see page 16
DX80N2Q45VT		
DX80N9Q45U	Q45 Universal Node with integrated batteries	
DX80N2Q45U		
DX80N9X1S-P6	1-wire Serial Performance Node with integrated battery	see page 50
DX80N2X1S-P6		
DX80N9X6S-P6	1-wire Serial Performance Node	
DX80N2X6S-P6		
DX80DR9M-H6	1-wire Serial Modbus MultiHop Slave with integrated battery	see page 58
DX80DR2M-H6		
QM42VT2 — Use with		
DX80DR9M-H1	Inputs: Four discrete, two 0 – 20 mA analog, one thermistor, one counter Outputs: Two NMOS discrete Switch Power Outputs: Two Serial Interface: RS-485	
DX80DR2M-H1		
DX80DR9M-H1E		
DX80DR2M-H1E		
DX80DR9M-H2	Inputs: Four discrete, two 0-20 mA analog Outputs: Four sourcing discrete, two 0-20 mA analog Serial Interface: RS-485	see page 58
DX80DR2M-H2		
DX80DR9M-HB1	Inputs: Two NPN discrete, two 0-20 mA analog Outputs: Two NMOS discrete Switch Power Outputs: Two	
DX80DR2M-HB1		
DX80DR9M-HB2	Inputs: Two PNP discrete, two 0-20 mA analog Outputs: Two PNP discrete, two 0-20 mA analog	
DX80DR2M-HB2		
DX80SR9M-H	Serial Interface: RS-232, RS-485	
DX80SR2M-H		

QM42VT Vibration and Temperature Sensor Specifications

Supply Voltage	3.6 to 5.5 V dc	
Current	Active comms: 11.9 mA at 5.5 V dc	
Communication Hardware	Interface: 1-wire Serial Interface Baud rates: 9.6k, 19.2k (default), or 38.4k Data format: 8 data bits, no parity (default), 1 stop bit (even or odd parity available)	
Communication Protocol	QM42VT2: Modbus RTU	QM42VT1: 1-wire Serial Interface
Communications Line	Level Receive ON: Greater than 2 V Level Receive OFF: Less than 0.7 V	Level Transmit ON: 2.7 to 3 V Level Transmit OFF: 0 V (pulldown resistor of 10 kOhm)
Vibration Sensor	Mounted base resonance: 5.5 kHz nominal Measuring Range: 0–65 mm/sec or 0–6.5 in/sec RMS	Frequency Range: 10–1000 Hz Accuracy: ±10% and 25 °C
Connector	3 m cable with 5-pin M12 fitting	
Indicators	Green flashing: Power ON	Amber flicker: Serial Tx
Temperature Sensor	Measuring Range: –40 °C to +105 °C (–40 °F to +221 °F)	Resolution: 0.1 °C Accuracy: ± 3 °C
Environmental Rating	NEMA 6P, IEC IP67	
Operating Conditions	–40 to 85 °C (–40 to 185 °F)	
Shock and Vibration	400G	

Wireless Ultrasonic Sensor



K50U



The Sure Cross® U-GAGE® K50U Ultrasonic Sensor works in a variety of environments to provide a measurement of the distance between the target and the sensor. It is designed for plug-and-play use with the Q45U wireless node, creating a cost-effective and easy-to-use solution for monitoring mobile or remote tanks and totes.

Key Features:

- Provides a distance measurement from the target to the sensor
- Three meter sensing range with a 300 mm dead zone
- Built-in temperature compensation
- Rugged design for demanding sensing environments; rated IEC IP67, NEMA 6P
- Two sensor models available; one with a 1-wire Serial Interface and one that functions as a Modbus slave via RS-485



Model	Description	
K50UX1RA	Ultrasonic sensor with 1-wire Serial Interface	
K50UX2RA	Ultrasonic sensor that functions as a modbus slave device via RS-485	
K50UX1RA—Used with		
DX80N9Q45U	Q45 Wireless Node with integrated battery	see page 16
DX80N2Q45U		
DX80N9X1S-P6	1-wire Serial Performance Node with integrated battery	
DX80N2X1S-P6		see page 50
DX80N9X6S-P6	1-wire Serial Performance Node	
DX80N2X6S-P6		
DX80DR9M-H6	1-wire Serial Modbus MultiHop Slave with integrated battery	see page 58
DX80DR2M-H6		
K50UX2RA—Used with		
DX80DR9M-H1	Inputs: Four discrete, two 0 – 20 mA analog, one thermistor, one counter	
DX80DR2M-H1	Outputs: Two NMOS discrete	
DX80DR9M-H1E	Switch Power Outputs: Two	
DX80DR2M-H1E	Serial Interface: RS-485	
DX80DR9M-H2	Inputs: Four discrete, two 0-20 mA analog	
DX80DR2M-H2	Outputs: Four sourcing discrete, two 0-20 mA analog	see page 58
DX80DR9M-HB1	Serial Interface: RS-485	
DX80DR2M-HB1	Inputs: Two NPN discrete, two 0-20 mA analog	
DX80DR9M-HB2	Outputs: Two NMOS discrete	
DX80DR2M-HB2	Switch Power Outputs: Two	
DX80SR9M-H	Inputs: Two PNP discrete, two 0-20 mA analog	
DX80SR2M-H	Outputs: Two PNP discrete, two 0-20 mA analog	
DX80SR9M-H	Serial Interface: RS-232, RS-485	
DX80SR2M-H		

K50U Specifications

Supply Voltage	3.6 to 5.5 V dc or 10 to 30 V dc	
Current	K50UX2RA: Active comms—11.3 mA at 30 V dc	K50UX1RA: Default sensing—180 µA Disabled sensing—40 µA Active comms—3.3 mA
Indicators	Green flashing: Power ON	Amber flicker: Serial Tx
Performance	Sensing range: 300 mm to 3 m (11.8 in to 118 in) Ultrasonic frequency: 114 kHz Temperature effect: 0.02% of distance/°C Resolution: 0.1% of distance (1.5 mm minimum)	
Discrete Inputs	One Sinking Rating: 3 mA max current at 30 V dc ON Condition: Less than 0.7 V OFF Condition: Greater than 2 V or open	
Communication Protocol	K50UX2RA: Modbus RTU	K50UX1RA: 1-wire Serial Interface
Environmental Rating	NEMA 6, IEC IP67	
Operating Conditions	–40 to 70 °C (–40 to 158 °F)	
Construction	Housing: PBT polyester Transducer: epoxy/ceramic composite	
Connector	Integral 5-pin M12/Euro-style male quick disconnect (QD)	
Communication Hardware	K50UX2RA: RS-485 Serial K50UX1RA: 1-Wire Serial Interface Baud Rates: 9.6k, 19.2k (default), or 38.4k Data Format: 8 data bits, No parity (default), even parity, or odd parity 1 stop bit Do not use a termination resistor.	
Communications Line	Level Receive ON: Greater than 2 V Level Receive OFF: Less than 0.7 V	Level Transmit ON: 2.7 to 3 V Level Transmit OFF: 0 V (pulldown resistor of 10 kOhm)
Shock and Vibration	All models meet Mil Std. 202F requirements. Method 201A (vibration: 10 Hz to 60 Hz max., double amplitude 0.06 inch, maximum acceleration 10G). Also meets IEC 947-5-2 requirements: 30G 11 ms duration, half sine wave	

Certifications



Photoelectric Q45 Sensors

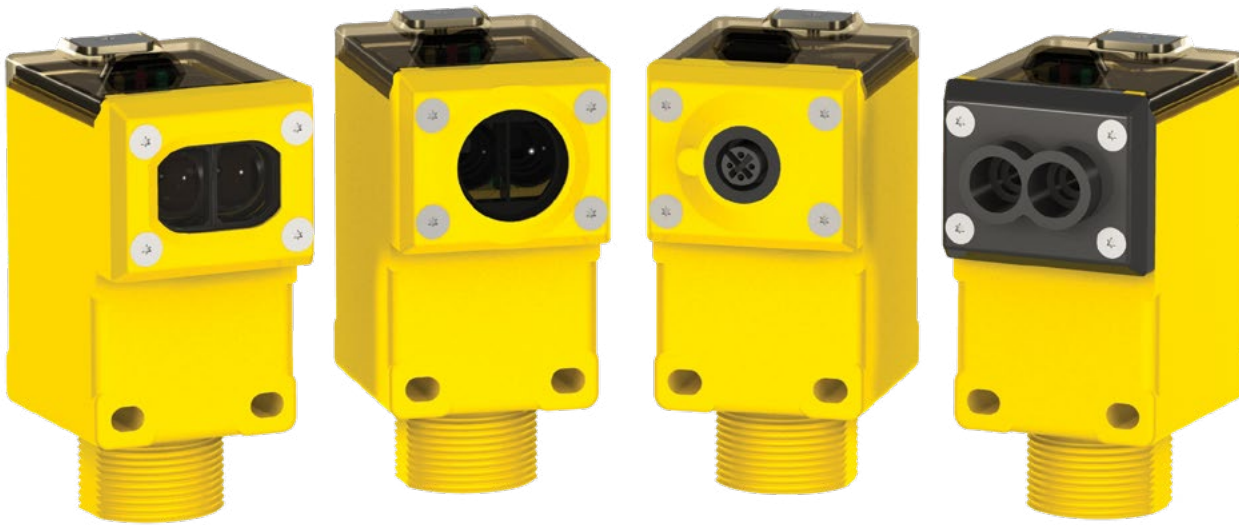

Q45 Sensors

The Sure Cross® Q45 is the first self-contained wireless standard photoelectric solution for the most challenging control and monitoring needs. Easily add a scalable wireless sensor network to improve efficiency by monitoring and coordinating multiple machines and processes without pulling cables.

Key Features:

- True self-contained wireless with no cables, cordsets or external power
- 1 km line-of-sight
- Built-in antenna
- Retroreflective and Diffuse models are preconfigured to count up to 960 parts per minute

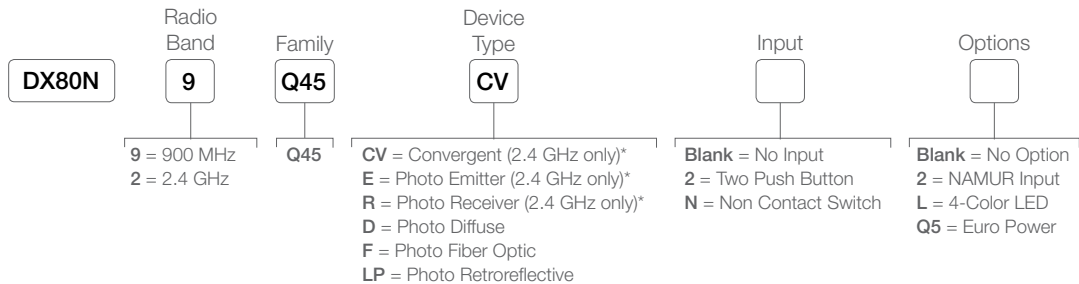

* Emitter and Receiver (E/R) are normally specified in pairs

Photoelectric Q45 Sensor Specifications

Radio (2.4 GHz)	Range: Up to 1000 m (3280 ft) with line of sight Transmit Power: 65 mW EIRP
2.4 GHz Compliance	FCC ID UE300DX80-2400 - This device complies with FCC Part 15, Subpart C, 15.247 ETSI/EN: In accordance with EN 300 328: V1.8.1 (2012-04) IC: 7044A-DX8024
Spread Spectrum Technology	FHSS (Frequency Hopping Spread Spectrum)
Construction	Molded reinforced thermoplastic polyester housing, oring-sealed transparent Lexan® cover, molded acrylic lenses, and stainless steel hardware. Q45s are designed to withstand 1200 psi washdown.
Typical Battery Life	Up to 2 years, typical A typical battery life assumes an average of 10 seconds between sensor changes of state and the default 62.5 millisecond sample rate. Battery life is reduced to 1 year with an average of 1 second between changes of state.
Default Sensing Interval	62.5 milliseconds
Adjustments	Multi-turn sensitivity control (allows precise sensitivity setting - turn clockwise to increase gain.
Sensing Range	Retroreflective: 0.15 m to 6 m (6 in to 20 ft) Diffuse: 101 mm to 300 mm (4 in to 12 in) Opposed: Up to 30 m (100 ft) depending on Excess Gain requirements Glass Fiber Optic: 1½-in focal point
Report Rate	On Change of State
Indicators	Red and green LEDs (radio function); amber LED (only for alignment mode)
Environmental Rating	NEMA 6P, IEC IP67
Operating Conditions	-40 °C to 70 °C (-40 °F to 158 °F); 90% relative humidity at 50 °C (non-condensing)

Q45 1-Wire Serial Models

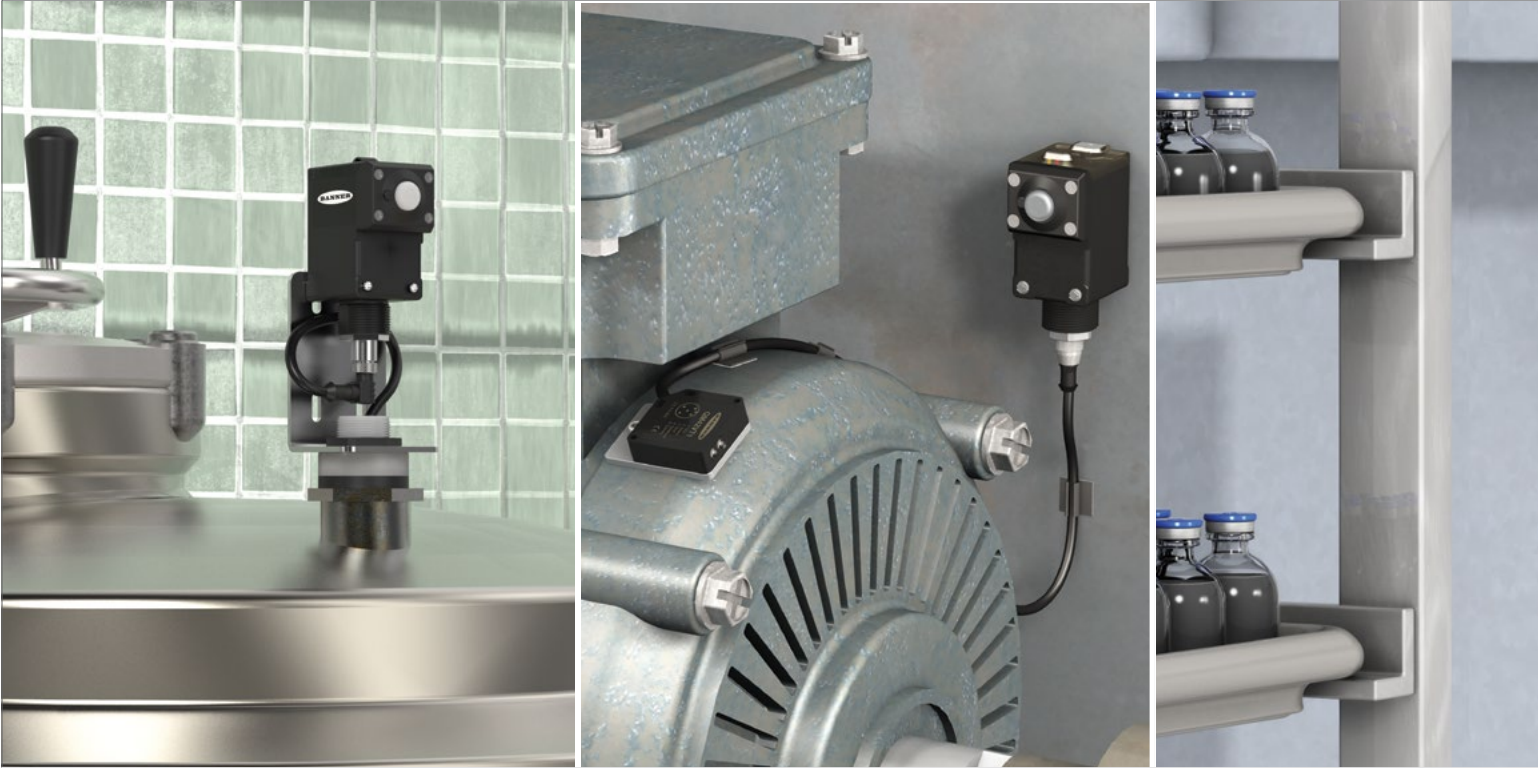

Q45U, Q45VT and Q45TH

The Q45 1-wire serial nodes are designed to pair with Banner 1-wire serial sensors. The compact size, integrated lithium batteries, and built-in LED indicator light make remote monitoring easy to do.

- The Q45U is a universal 1-wire serial node that reads any Banner 1-wire serial sensor and determines an efficient power setting accordingly. It includes a red/green/yellow/blue LED to provide local indication.
- The Q45VT is designed to pair with the QM42VT1 vibration and temperature sensor; vibration thresholds can be set using dip switches and a built-in LED is pre-mapped to illuminate when a threshold has been exceeded.
- The Q45TH connects directly to the M12FTH4Q temperature and humidity sensor; sample rates can be set using DIP switches, and a red/green LED can be used to provide local indication.

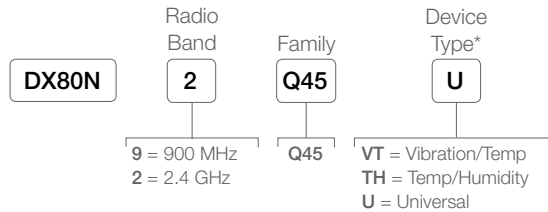

* Sensor units must be ordered separately

Q45VT, Q45TH, Q45U Specifications

	900 MHz	2.4 GHz
Radio Range	Up to 3.2 Km (2 miles) with line of sight	Up to 1000 m (3280 ft) with line of sight
Minimum Separation Distance	4.57 m (15 ft)	0.3 m (1 ft)
Transmit Power	1W (25 dBm)	65 mW
Compliance	FCC ID UE3RM1809 - This device complies with FCC Part 15, Subpart C, 15.247 ETSI EN 300 328 V1.8.1 IC: 7044A-RM1809	FCC ID UE300DX80-2400 - This device complies with FCC Part 15, Subpart C, 15.247 ETSI EN 300 328 V1.8.1 (2012-06) IC: 7044A-DX8024
Spread Spectrum Technology	FHSS (Frequency Hopping Spread Spectrum)	
Default Sensing Interval	Q45VT: 5 minutes Q45TH: 64 seconds Q45U: 5 minutes	
Temperature Sensor	Measuring Range: -40 °C to +85 °C (-40 °F to +185 °F) Resolution: 0.1 °C Accuracy: ±0.3 °C	
Humidity Sensor	Measuring Range: 0% to 100% relative humidity Resolution: 0.1% relative humidity Accuracy: ±2% relative humidity at 23 °C	
Indicators	Red and green LEDs (radio function)	
Connection	One 5-pin threaded M12/Euro-style female quick-disconnect	
Construction	Molded reinforced thermoplastic polyester housing, oring-sealed transparent Lexan® cover, molded acrylic lenses, and stainless steel hardware. Q45s are designed to withstand 1200 psi washdown.	
Typical Battery Life at Default Sensing Interval	Q45VT: Up to 2.5 years Q45TH: Up to 1.5 years Q45U: 2+ years	Q45VT: Up to 3 years Q45TH: Up to 2 years Q45U: 3+ years
Environmental Rating	NEMA 6P, IEC IP67	
Operating Conditions	-40 °C to 70 °C (-40 °F to 158 °F); 90% relative humidity at 50 °C (non-condensing)	

Q45 Switches and Pushbuttons

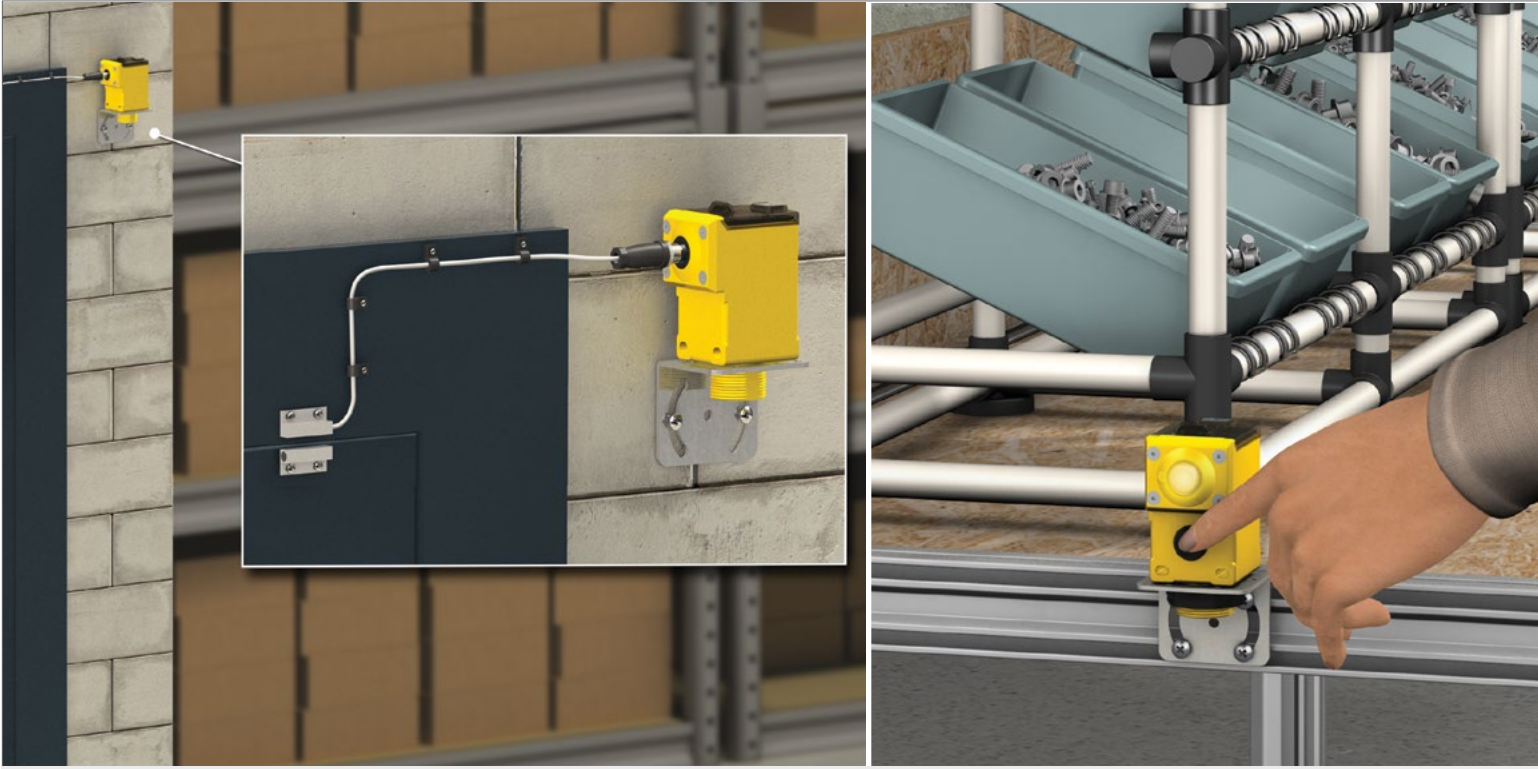

Q45RD and Q45BL

This Q45 family of products is designed to accept remote dry contact, NAMUR and discrete non-contact switch inputs to be used in many factory automation, remote monitoring and IIoT applications.

- Remote device models are designed to interface with isolated dry contact inputs or NAMUR inductive proximity sensors.
- Button and light models have independently controlled push button inputs and a multi-color LED indicator light.
- Remote discrete non-contact switch models use a magnet to sense the position of mechanical devices, such as doors, levers, valves, and other actuators.

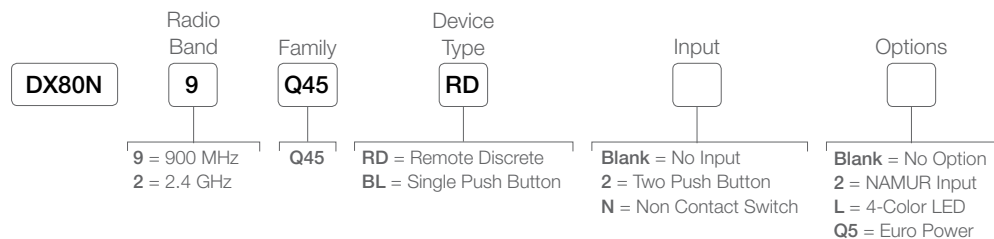

Q45RD and Q45BL Specifications

	900 MHz	2.4 GHz
Radio Range	Up to 3.2 Km (2 miles) with line of sight	Up to 1000 m (3280 ft) with line of sight
Minimum Separation Distance	1W: 4.57 m (15 ft) 150/250 mW: 2 m (6 ft)	0.3 m (1 ft)
Transmit Power	1W (25 dBm)	65 mW EIRP
Compliance	FCC ID UE3RM1809 - This device complies with FCC Part 15, Subpart C, 15.247 ETSI EN 300 328 V1.8.1 IC: 7044A-RM1809	FCC ID UE300DX80-2400 - This device complies with FCC Part 15, Subpart C, 15.247 ETSI/EN: In accordance with EN 300 328: V1.8.1 (2012-06) IC: 7044A-DX8024
Spread Spectrum Technology	FHSS (Frequency Hopping Spread Spectrum)	
Externally Powered Sourcing Sensors (Q45RD models)	ON Condition: 2 V to 5 V OFF Condition: Less than 1 V	
Button Input (Q45BL models)	Sample Rate: 62.5 milliseconds Report Rate: On change of state	ON Condition: Button pressed OFF Condition: Button not pressed
Construction	Molded reinforced thermoplastic polyester housing, oring-sealed transparent Lexan® cover, molded acrylic lenses, and stainless steel hardware. Q45s are designed to withstand 1200 psi washdown.	
Indicators	Red and green LEDs (radio function); amber LED indicates when input 1 is active	
Environmental Rating	NEMA 6P, IEC IP67	
Battery Life	See Datasheet	
Default Sample Rate	62.5 milliseconds (dry contact) or 125 milliseconds (NAMUR)	
Report Rate	On Change of State	
Operating Conditions	-40 °C to 70 °C (-40 °F to 158 °F); 90% relative humidity at 50 °C (non-condensing)	
Certifications		

6-Button Pendant

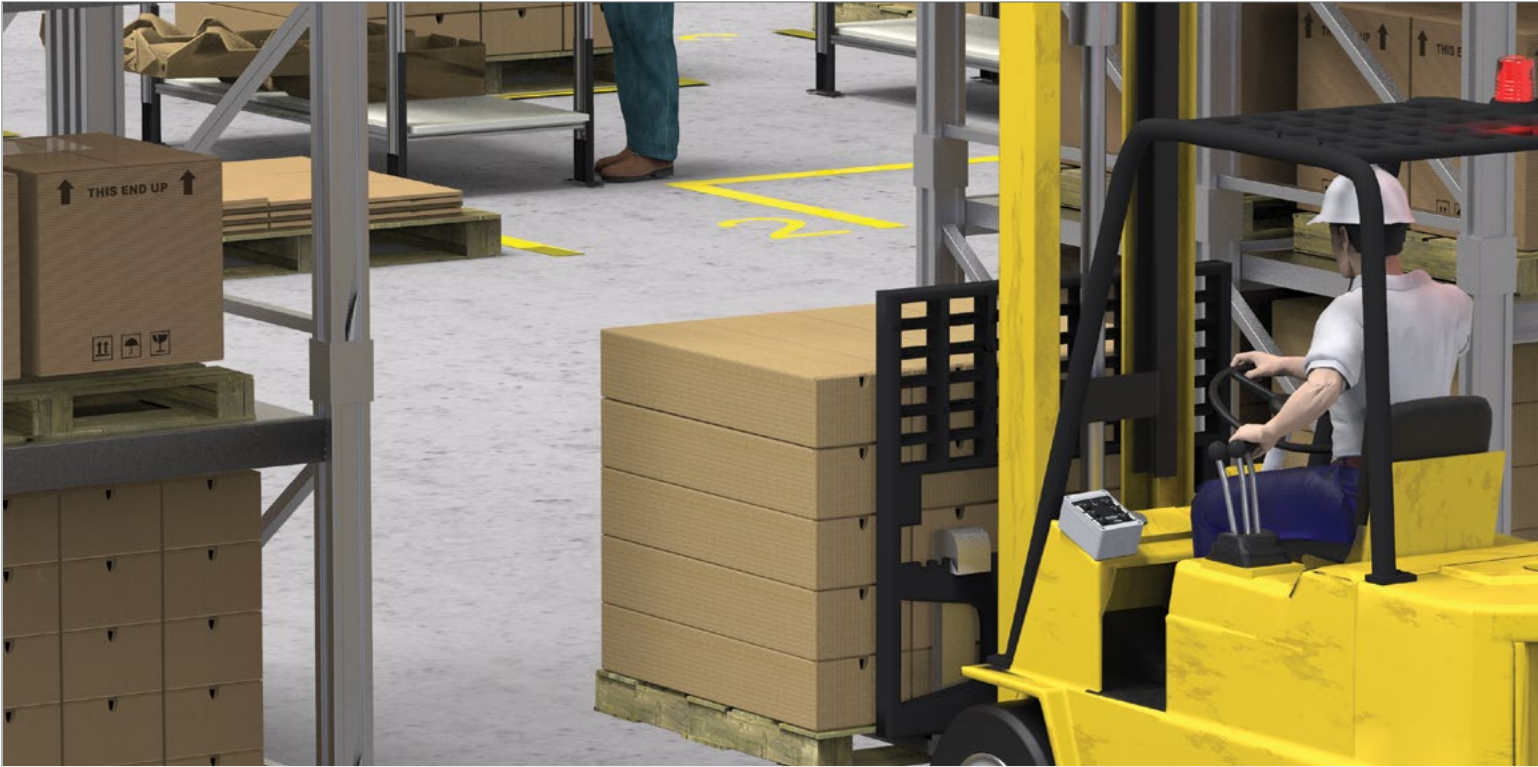

Q120

The Sure Cross® Wireless Q120 button and light pendant is an autonomous wireless Node that enables two-way communication between an operator and up to six remote and/or mobile devices. Six independently controlled push-button inputs allow operators to wirelessly send status updates, acknowledgements, initiate processes, and actuate devices.

Key Features:

- DIP switch configurable
- Six push-button inputs with momentary or toggle operation
- Six sets of red and green LED indicator lights with solid or flashing operation
- Reliable, field-proven wireless architecture operates in the globally accepted 2.4 GHz frequency band or the long-range 900 Mhz frequency band, depending upon model

Applications:

- Call for parts, service, or pick up
- Motor, fan, pump control and status indication
- Light control

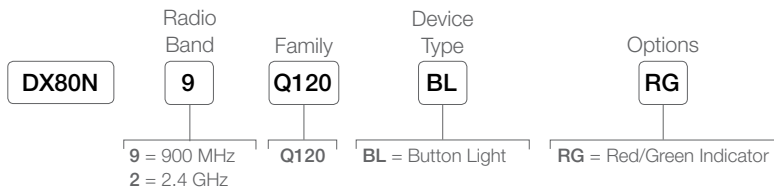

Q120 Specifications

	900 MHz	2.4 GHz
Radio Range	Up to 3.2 Km (2 miles)	Up to 1000 m (3280 ft)
Minimum Separation Distance	4.57 m (15 ft)	0.3 m (1 ft)
Compliance	FCC ID UE3RM1809: This device complies with FCC Part 15, Subpart C, 15.247 IC: 7044A-RM1809	FCC ID UE300DX80-2400 - This device complies with FCC Part 15, Subpart C, 15.247 ETSI EN 300 328 V1.8.1 (2012-06) IC: 7044A-DX8024
Spread Spectrum Technology	FHSS (Frequency Hopping Spread Spectrum)	
Construction	Polycarbonate housing; polyester labels; EDPM rubber cover gasket; nylon buttons Weight: 0.39 kg (0.85 lbs) Maximum Tightening Torque: 0.56 N·m (5 lbf·in)	
Indicators	Red and green LEDs (radio function)	
Environmental Rating	NEMA 6, IEC IP67	
Battery Life	See Datasheet	
Operating Conditions	-40 °C to 70 °C (-40 °F to 158 °F); 90% relative humidity at 50 °C (non-condensing)	

Wireless Tower Light



TL70

Easily add wireless communication and networking capabilities to your tower lights by using Banner's Wireless Base or Wireless Communication Segment.

Key Features:

- Easily add IIoT remote monitoring capabilities
- Enable Overall Equipment Effectiveness (OEE) data collection to optimize your operation
- Receive timely status information and remote notifications of problems
- Simplify installation by not having to run control wires
- Rugged, water-resistant IP65 housing with UV-stabilized material allows for use in harsh environments

Two options to add wireless communication to tower lights



Wireless Base

The Wireless Base provides full bi-directional communication, plus event counter inputs. It can be configured into preassembled tower lights,

Buy this if:

- You want to buy a preassembled tower light with wireless connectivity
- You can supply constant power to the light
- Your machines have PNP outputs to the tower light
- Your sole intent is to control light segments via the wireless radio

Wireless Communication Segment

The Communication segment adds wireless communication and networking capabilities to any standard TL70 Base, without requiring constant power or expensive wiring.

Buy this if:

- You want to add wireless connectivity to an existing TL70 Tower Light
- You can not supply constant power to the light
- Your machines have both NPN and PNP inputs
- You have a TL70 ac base



	Segment	Base
Requires Constant Power	—	✓
PNP Inputs	✓	✓
NPN Inputs	✓	—
AC Power Capable	✓	—
900 MHz and 2.4 GHz	✓	✓
Event Counting Input	✓	✓
Bidirectional Communication	✓	✓
Remote Control of Light Segments	✓*	✓

* Requires constant power

Build your Own



Wireless Base

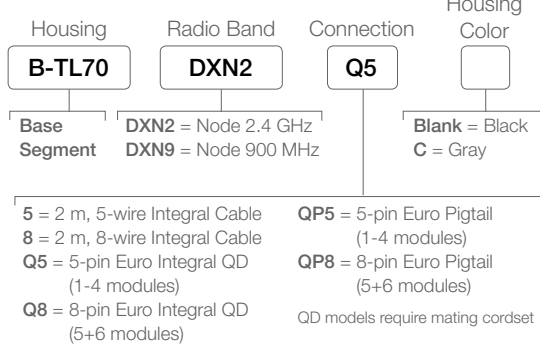

Single Color Segments

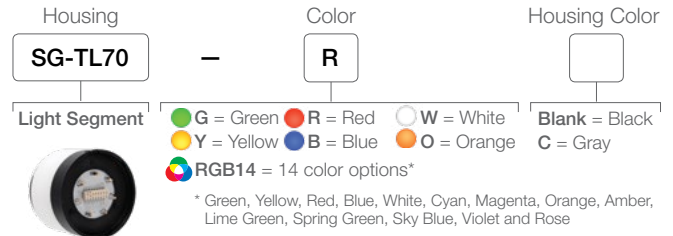

Standard Base

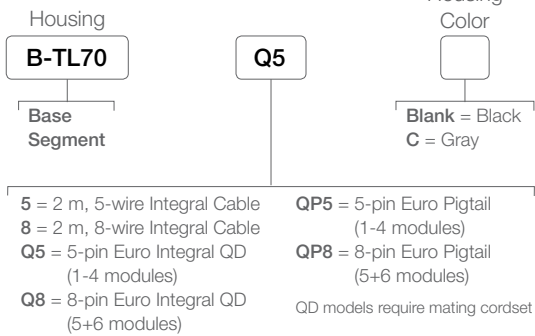

Audible Segments

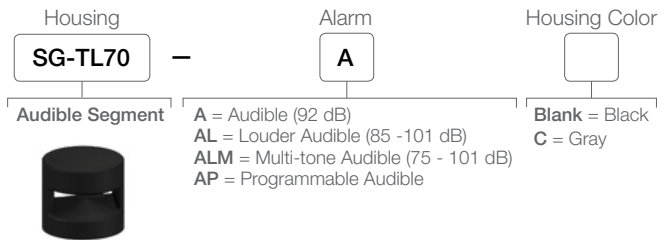

Multicolor Segments

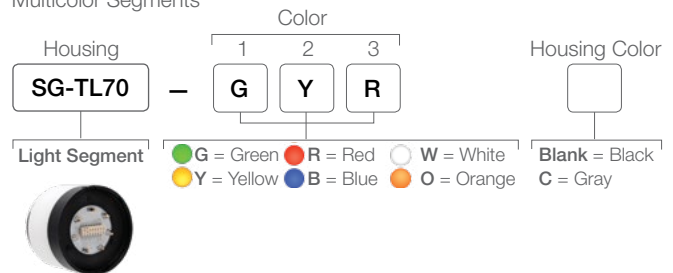

AC Base

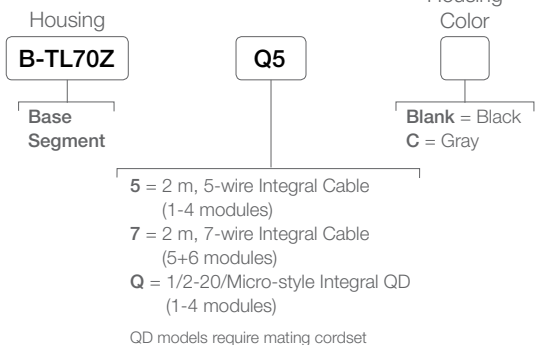

Communication Segment

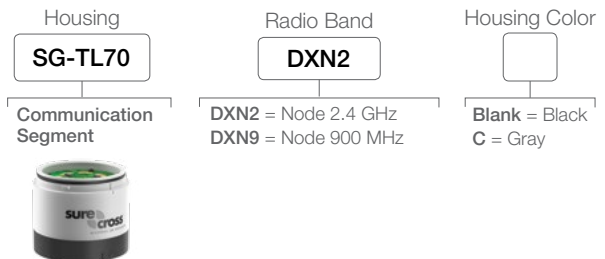



Preassembled

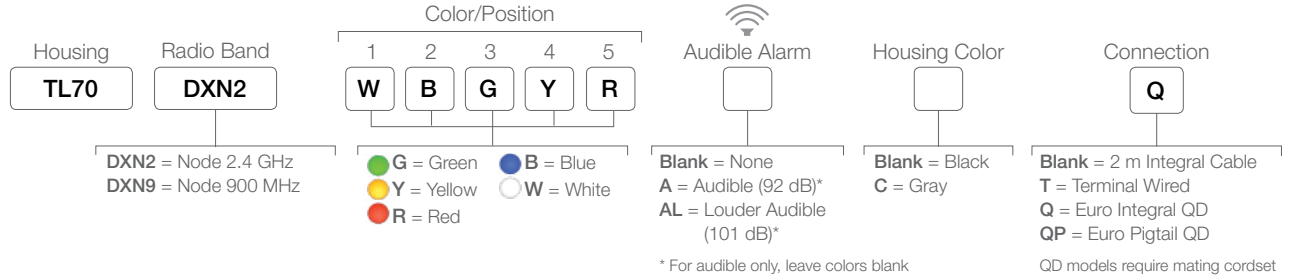

TL70 Wireless Tower Light Specifications

Supply Voltage	12 to 30 V dc (Outside the USA: 12 to 24 V dc, ± 10%)	
Supply Protection Circuitry	Protected against transient voltages	
Indicator Response Time	OFF Response: 150 µs (maximum) at 12 to 30 V dc ON Response: 180 ms (maximum) at 12 V dc; 50 ms (maximum) at 30 V dc	
Audible Alarm	2.6 KHz ± 250 Hz oscillation frequency; maximum intensity 92 dB (Audible) and 101dB (Louder Audible) at 1 m (3.3 ft) (typical)	
Indicators	1 to 5 colors depending on model: Green, Red, Yellow, Blue, and White Flash rates: 1.5 Hz ±10% and 3 Hz ±10% LEDs are independently selected	
Construction	Bases, segments, covers: polycarbonate	
Operating Conditions	-40 °C to +50 °C (-40 °F to +122 °F) 95% at +50 °C maximum relative humidity (non-condensing)	
Environmental Rating	IEC IP65	
Vibration and Mechanical Shock	Vibration 10 to 55 Hz 0.5 mm p-p amplitude per IEC60068-2-6 Shock 15G 11 ms duration, half sine wave per IEC60068-2-27	
Radio Range	900 MHz, 1 W: Up to 9.6 km (6 miles)	2.4 GHz, 65 mW: Up to 3.2 km (2 miles)
Minimum Separation Distance	900 MHz 1 W: 4.57 m (15 ft)	2.4 GHz 65 mW: 0.3 m (1 ft)
Radio Transmit Power	900 MHz, 1 W: 30 dBm (1 W) conducted (up to 36 dBm EIRP)	2.4 GHz, 65 mW: 18 dBm (65 mW) conducted, ≤ 20 dBm (100 mW) EIRP
Compliance	900 MHz Compliance (1 Watt) FCC ID UE3RM1809: This device complies with FCC Part 15, Subpart C, 15.247 IC: 7044A-RM1809	2.4 GHz Compliance FCC ID UE300DX80-2400 - This device complies with FCC Part 15, Subpart C, 15.247 ETSI EN 300 328 V1.8.1 (2012-06) IC: 7044A-DX8024
Radiated Immunity HF	10 V/m (EN 61000-4-3)	
Spread Spectrum Technology	FHSS (Frequency Hopping Spread Spectrum)	
Link Timeout	Gateway: Configurable via User Configuration Tool (UCT) software	Node: Defined by Gateway
Certifications		

Wireless Indicator



K70

Wireless K70 Indicators are bright, 70 mm multicolored indicators offering increased communication possibilities and greater versatility in deployment.

Key Features:

- Models are available with up to five colors in one device
- Rugged, water-resistant IP65 housing
- SureCross wireless node built into the base
- 900 MHz and 2.4 GHz wireless options
- Input wires can be configured as auxiliary sourcing inputs from external devices or as a 20 Hz, 32-bit event counter

Applications:

- Clean room status indication
- Loading dock status
- High traffic forklift crossing status

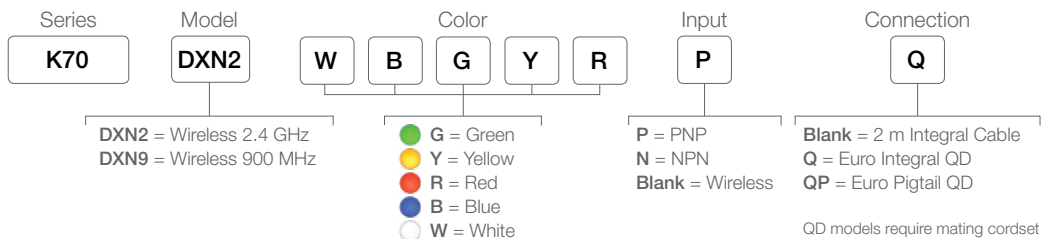

K70 Wireless Indicator Light Specifications

Supply Voltage	12 to 30 V dc (Outside the USA: 12 to 24 V dc, ± 10%)	
Supply Protection Circuitry	Protected against transient voltages	
Indicator Response Time	OFF Response: 150 µs (maximum) at 12 to 30 V dc ON Response: 180 ms (maximum) at 12 V dc; 50 ms (maximum) at 30 V dc	
Audible Alarm	2.6 KHz ± 250 Hz oscillation frequency; maximum intensity 92 dB (Audible) and 101dB (Louder Audible) at 1 m (3.3 ft) (typical)	
Indicators	OFF Response: 150 µs (maximum) at 12 to 30 V dc ON Response: 180 ms (maximum) at 12 V dc; 50 ms (maximum) at 30 V dc	
Construction	Bases and cover: polycarbonate	
Operating Conditions	-40 °C to +50 °C (-40 °F to +122 °F) 95% at +50 °C maximum relative humidity (non-condensing)	
Environmental Rating	IEC IP65	
Vibration and Mechanical Shock	Vibration 10 to 55 Hz 0.5 mm p-p amplitude per IEC60068-2-6 Shock 15G 11 ms duration, half sine wave per IEC60068-2-27	
Radio Range	900 MHz, 1 W: Up to 3.2 km (2 miles)	2.4 GHz, 65 mW: Up to 1000 m (3280 ft)
Minimum Separation Distance	900 MHz 1 W: 4.57 m (15 ft)	2.4 GHz 65 mW: 0.3 m (1 ft)
Compliance	FCC ID UE3RM1809: This device complies with FCC Part 15, Subpart C, 15.247 IC: 7044A-RM1809	FCC ID UE300DX80-2400 - This device complies with FCC Part 15, Subpart C, 15.247 ETSI EN 300 328 V1.8.1 (2012-06) IC: 7044A-DX8024
Radiated Immunity HF	10 V/m (EN 61000-4-3)	
Spread Spectrum Technology	FHSS (Frequency Hopping Spread Spectrum)	
Link Timeout	Gateway: Configurable via User Configuration Tool (UCT) software	Node: Defined by Gateway

Certifications



Wireless Touch Button



K70

The K70 Wireless Touch Button is an ergonomic solid-state switch with integrated multicolor indication functions and a wireless Node. Bidirectional wireless communication provides a simple operator interface for many industrial applications.

Key Features:

- Bidirectional wireless communication
- Ergonomically designed to eliminate hand, wrist, and arm stresses associated with repeated switch operation; requires no physical force to operate
- Can be actuated with bare hands or in gloves
- Up to three colors in one touch button; momentary and latching versions available
- Excellent immunity to false triggering by water spray, detergents, oils, and other foreign materials

Applications:

- Pick-to-light
- Call button
- General industrial applications

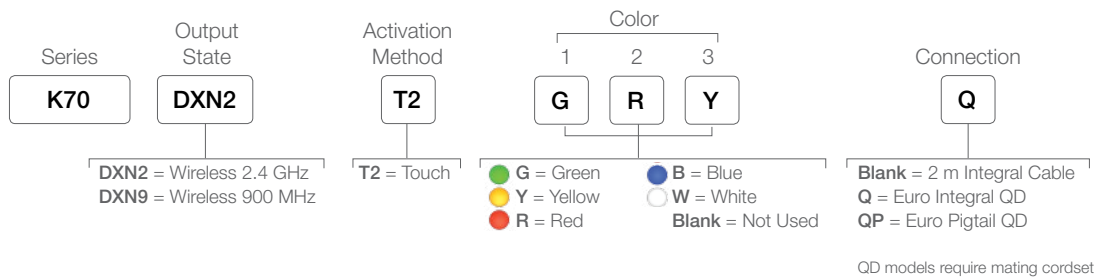

K70 Wireless Touch Button Specifications

Supply Voltage	12 to 30 V dc (Outside the USA: 12 to 24 V dc, ± 10%)	
Supply Current	< 220 mA maximum current at 12 V dc < 110 mA maximum current at 30 V dc	
Supply Protection Circuitry	Protected against transient voltages	
Indicators	1 to 3 colors depending on model: Green, Red, Yellow, Blue, and White LEDs are independently selected	
Indicator Response Time	OFF Response: 150 μs (maximum) at 12 to 30 V dc ON Response: 180 ms (maximum) at 12 V dc; 50 ms (maximum) at 30 V dc	
Construction	Bases and cover: polycarbonate	
Operating Conditions	-40 °C to +50 °C (-40 °F to +122 °F) 95% at +50 °C maximum relative humidity (non-condensing)	
Environmental Rating	IEC IP65	
Vibration and Mechanical Shock	Vibration 10 to 55 Hz 0.5 mm p-p amplitude per IEC60068-2-6 Shock 15G 11 ms duration, half sine wave per IEC60068-2-27	
Radio Range	900 MHz, 1 W: Up to 3.2 km (2 miles)	2.4 GHz, 65 mW: Up to 1000 m (3280 ft)
Minimum Separation Distance	900 MHz 1 W: 4.57 m (15 ft)	2.4 GHz 65 mW: 0.3 m (1 ft)
Compliance	FCC ID UE3RM1809: This device complies with FCC Part 15, Subpart C, 15.247 IC: 7044A-RM1809	FCC ID UE300DX80-2400 - This device complies with FCC Part 15, Subpart C, 15.247 ETSI EN 300 328 V1.8.1 (2012-06) IC: 7044A-DX8024
Radiated Immunity HF	10 V/m (EN 61000-4-3)	
Spread Spectrum Technology	FHSS (Frequency Hopping Spread Spectrum)	
Link Timeout	Gateway: Configurable via User Configuration Tool (UCT) software	Node: Defined by Gateway

Certifications







Controllers

Industrial wireless controllers that facilitate industrial Internet of Things (IIoT) applications.

DXM100 Wireless Controller

The DXM100 Controller is an industrial wireless controller developed to facilitate Ethernet connectivity and Industrial Internet of Things (IIoT) applications. Available with an internal DX80 Gateway or a MultiHop Data Radio, this powerful Modbus communications device connects local wireless networks with the internet and/or host systems.

Key Features:

- ISM radios available in 900 MHz and 2.4 GHz for local wireless network
- Converts Modbus RTU to Modbus TCP/IP or Ethernet I/P
- Logic controller can be programmed using action rules and text language methods
- Cellular connectivity
- Micro SD card for data logging
- Email and text alerts
- Local I/O options: universal inputs, NMOS outputs, and analog outputs
- Powered by 12 to 30 V dc, 12 V dc solar panel, or battery backup
- RS-232, RS-485, and Ethernet communications ports; and a USB configuration port
- LCD display for I/O information and user programmable LEDs

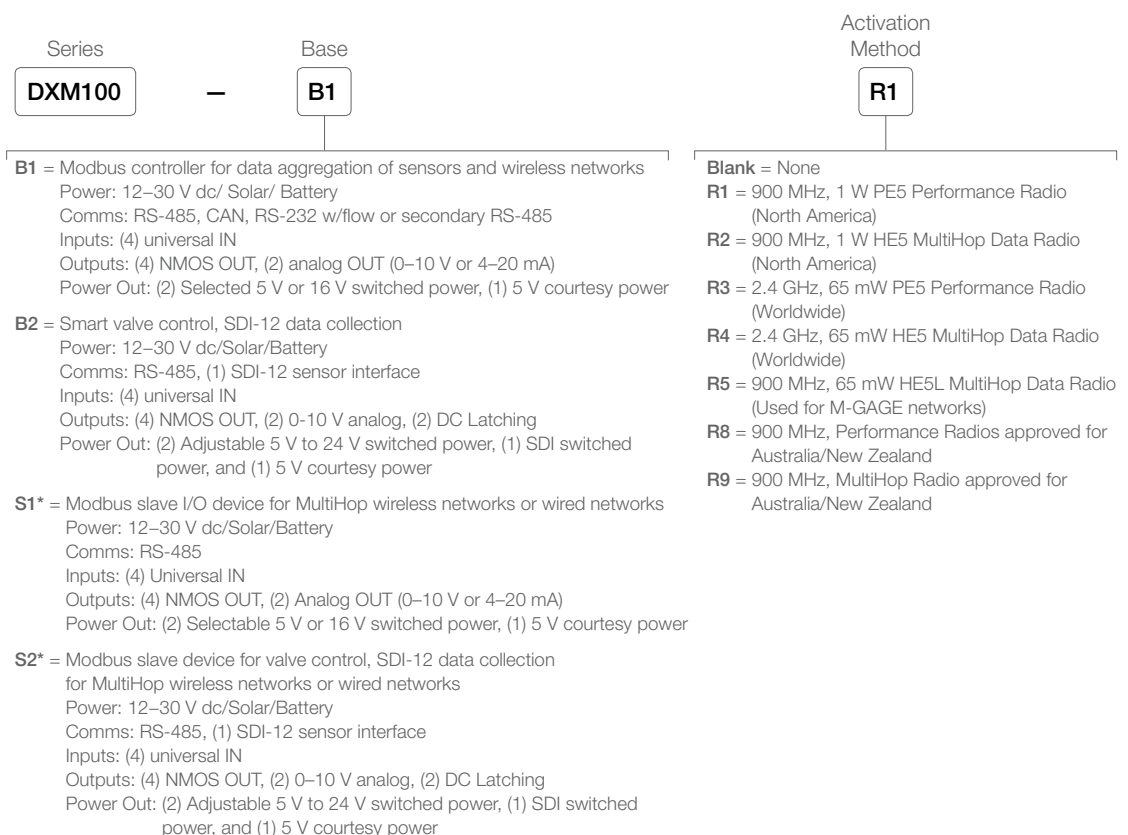

* For S1 and S2 models, only order the R2, R4, R5, and R9 radio configurations

Cellular Communication

Controllers accept Banner GSM and LTE modems only. Cellular modems are ordered separately as accessories under the following part numbers:

- GSM/3G (HSPA) – **SXI-GSM-001**
- LTE – Verizon – **SXI-LTE-001**

DXM100 Controllers Specifications

Supply Voltage	12 to 30 V dc use only with a suitable Class 2 power supply (UL) or 9 SELV (CE) powers supply or 12 V dc solar panel and 12 V sealed lead acid battery	
Power Consumption	B1 and B2 models: 35 mA average at 12 V	S1 and S2 models: 20 mA average at 12 V
Solar Power Battery Charging	1 Amp maximum with 20 Watt solar panel	
Radio (ISM Band) Transmit Power	900 MHz at 1 Watt	2.4 GHz at 65 mW
Radio Range	900 MHz, 1 Watt: Up to 9.6 km (6 miles)	2.4 GHz, 65 mW: Up to 3.2 km (2 miles)
Minimum Separation Distance	900 MHz, 1 Watt: 4.57 m (15 ft) 900 MHz, 150/250 mW: 2 m (6 ft)	2.4 GHz, 65 mW: 0.3 m (1 ft)
Antenna Connection	Ext. Reverse Polarity SMA, 50 Ohms Max Tightening Torque: 0.45 N-m (4 lbf-in)	
Radio Transmit Power	900 MHz, 1 Watt: 30 dBm (1 Watt) conducted (up to 36 dBm EIRP)	2.4 GHz, 65 mW: 18 dBm (65 mW) conducted, less than or equal to 20 dBm (100 mW EIRP)
Compliance	900 MHz Compliance (1 Watt) FCC ID UE3RM1809: This device complies with FCC Part 15, Subpart C, 15.247 IC: 7044A-RM1809	2.4 GHz Compliance FCC ID UE300DX80-2400 - This device complies with FCC Part 15, Subpart C, 15.247 ETSI/EN: In accordance with EN 300 328: V1.8.1 (2012-04) IC: 7044A-DX8024
Spread Spectrum Technology	FHSS (Frequency Hopping Spread Spectrum)	
Logging	8 GB maximum; removable Micro SD card format	
Protocols	Modbus RTU Master/Slave, Modbus TCP, and Ethernet/IP	
Construction	Polycarbonate; DIN rail mount option	
Communication Hardware (RS-232)	2-wire full duplex; flow control -15 to +15 Volts signaling Baud rates: 9.6k, 19.2k (default), or 38.4k Data format: 8 data bits, no parity, 1 stop bit	
Communication Hardware (RS-485)	2-wire half duplex RS-485 Baud rates: 9.6k, 19.2k (default), or 38.4k Data format: 8 data bits, odd, even or no parity, 1 stop bit	
Universal Inputs	Discrete sinking/sourcing, 4 to 20 mA analog, 0 to 10 V analog, 10k thermistor, counter	
Courtesy Power	One output at 5 volts, 500 mA maximum	
Switched Power Outputs	B1 and S1 models: Two selectable 5 V or 16 V outputs 5 V: 400 mA maximum 16 V: 125 mA maximum	B2 and S2 models: Two adjustable 5 V or 24 V outputs One SDI-12 adjustable 5 V to 24 V output 5 V: 400 mA maximum 16 V: 125 mA maximum 24 V: 85 mA maximum
Environmental Rating	IEC IP20	
Operating Conditions	-40 °C to +85 °C (-40 °F to +185 °F) (Electronics); -20 °C to +80 °C (-4 °F to +176 °F) (LCD) 95% maximum relative humidity (non-condensing) Radiated Immunity: 10 V/m, 80-2700 MHz (EN 61000-4-3)	
Shock and Vibration	IEC 68-2-6 and IEC 68-2-27 Shock: 30g, 11 millisecond half sine wave, 18 shocks Vibration: .5 mm p-p, 10 to 60 Hz	
Analog Outputs	0 to 20 mA or 0 to 10 V dc output Accuracy: 0.1% of full scale +0.01% per °C Resolution: 12 bit	
Certifications		

DXM150 Wireless Controller

The DXM150 Controller is an industrial wireless controller developed to facilitate Ethernet connectivity and Industrial Internet of Things (IIoT) applications. Available with an internal DX80 Gateway or a MultiHop Data Radio, this powerful Modbus communications device has expanded I/O options and connects local wireless networks with the internet and/or host systems.



Key Features:

- ISM radios available in 900 MHz and 2.4 GHz for local wireless network
- Converts Modbus RTU to Modbus TCP/IP or Ethernet I/P
- Logic controller can be programmed using action rules and text language methods
- Cellular connectivity
- Micro SD card for data logging
- Email and text alerts
- Local I/O options: 8 universal inputs, NMOS outputs, and relay and analog outputs
- Powered by 12 to 30 V dc, 12 V dc solar panel, or battery backup
- RS-232, RS-485, and Ethernet communications ports; and a USB configuration port
- LCD display for I/O information and user programmable LEDs

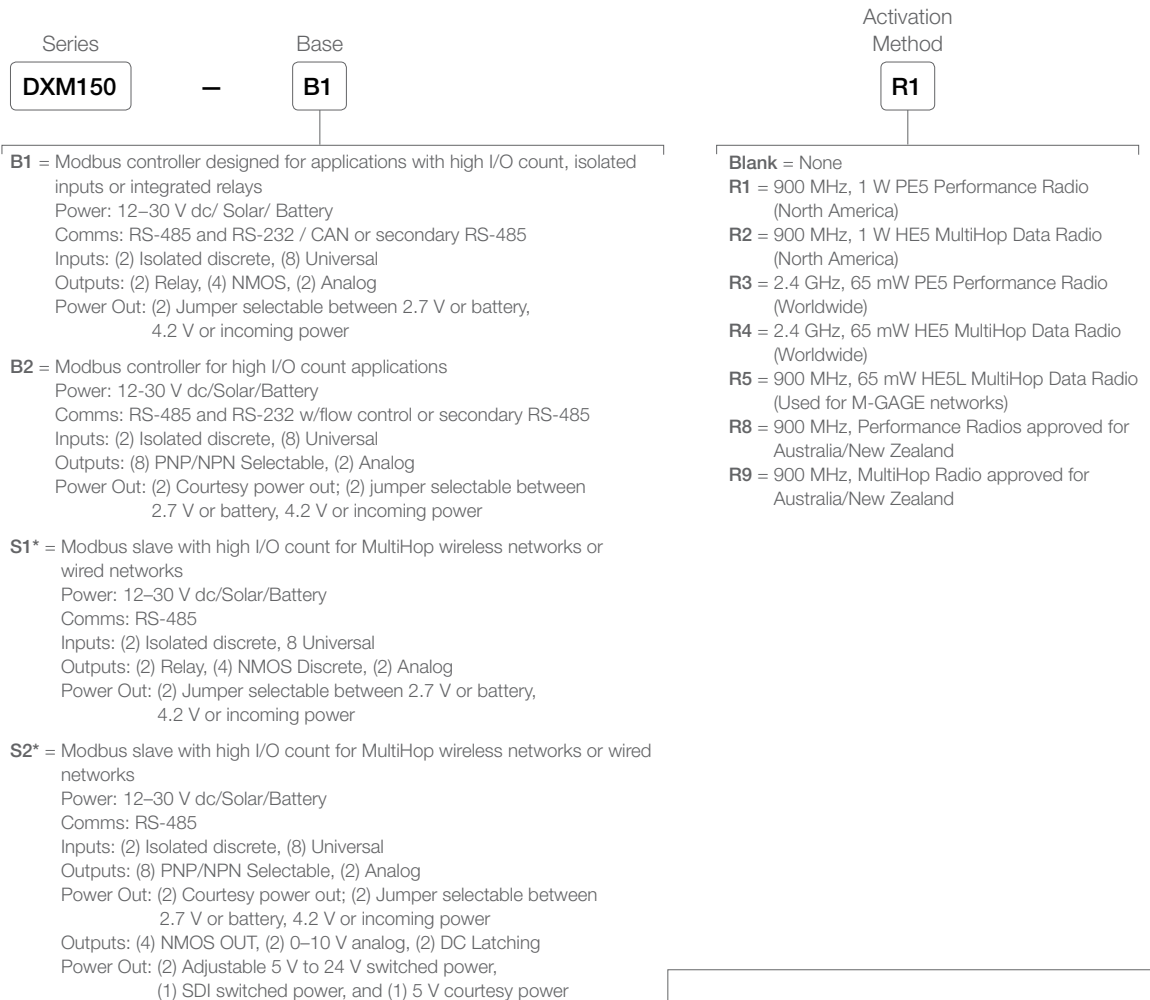

* For S1 and S2 models, only order the R2, R4, R5, and R9 radio configurations

Cellular Communication
 Controllers accept Banner GSM and LTE modems only. Cellular modems are ordered separately as accessories under the following part numbers:

- GSM/3G (HSPA) – **SXI-GSM-001**
- LTE – Verizon – **SXI-LTE-001**

DXM150 Controllers Specifications

Supply Voltage	12 to 30 V dc or 12 V dc solar panel and 12 V sealed lead acid battery	
Power Consumption	B1 and B2 models: 35 mA average at 12 V	S1 and S2 models: 20 mA average at 12 V
Solar Power Battery Charging	1 Amp maximum with 20 Watt solar panel	
Radio (ISM Band) Transmit Power	900 MHz at 1 Watt	2.4 GHz at 65 mW
Radio Range	900 MHz, 1 Watt: Up to 9.6 km (6 miles)	2.4 GHz, 65 mW: Up to 3.2 km (2 miles)
Minimum Separation Distance	900 MHz, 1 Watt: 4.57 m (15 ft)	2.4 GHz, 65 mW: 0.3 m (1 ft)
Antenna Connection	Ext. Reverse Polarity SMA, 50 Ohms Max Tightening Torque: 0.45 N-m (4 lbf-in)	
Radio Transmit Power	900 MHz, 1 Watt: 30 dBm (1 Watt) conducted (up to 36 dBm EIRP)	2.4 GHz, 65 mW: 18 dBm (65 mW) conducted, less than or equal to 20 dBm (100 mW EIRP)
Compliance	900 MHz Compliance (1 Watt) FCC ID UE3RM1809: This device complies with FCC Part 15, Subpart C, 15.247 IC: 7044A-RM1809	2.4 GHz Compliance FCC ID UE300DX80-2400 - This device complies with FCC Part 15, Subpart C, 15.247 ETSI/EN: In accordance with EN 300 328: V1.8.1 (2012-04) IC: 7044A-DX8024
Spread Spectrum Technology	FHSS (Frequency Hopping Spread Spectrum)	
Logging	8 GB maximum; removable Micro SD card format	
Protocols	Modbus RTU Master/Slave, Modbus TCP, and Ethernet/IP	
Construction	Polycarbonate; DIN rail mount option	
Communication Hardware (RS-232)	Interface: 2-wire RS-232 Baud rates: 9.6k, 19.2k (default), or 38.4k via DIP switches; 1200 and 2400 via the MultiHop Configuration Tool Data format: 8 data bits, no parity, 1 stop bit	
Communication Hardware (RS-485)	Interface: 2-wire half-duplex RS-485 Baud rates: 9.6k, 19.2k (default), or 38.4k via DIP switches; 1200 and 2400 via the MultiHop Configuration Tool Data format: 8 data bits, no parity, 1 stop bit	
Switched Power Outputs	5 Volts/400 mA maximum; 16 V/125 mA maximum	
Environmental Rating	IEC IP20	
Operating Conditions	-40 °C to +85 °C (-40 °F to +185 °F) (Electronics); -20 °C to +80 °C (-4 °F to +176 °F) (LCD) 95% maximum relative humidity (non-condensing) Radiated Immunity: 10 V/m (EN 61000-4-3)	
Shock and Vibration	IEC 68-2-6 and IEC 68-2-27 Shock: 30g, 11 millisecond half sine wave, 18 shocks Vibration: .5 mm p-p, 10 to 60 Hz	
Selectable (Jumper) Power Out	Output on pin 45, jumper selects 2.7 V or battery Output on pin 35, jumper selects 4.2 V or incoming power 100 mA maximum	
Discrete Inputs	Optically isolated AC input type Input to output isolation: 2.5 kV	
Counters, Synchronous	32-bits unsigned 10 ms clock rate minimum	
Universal Inputs	Sinking/Sourcing discrete, 4-20 mA analog, 0-10 V analog, counter, and temperature 10 kOhm thermistor	
Indicators	Four LEDs, four control buttons, one LCD	
Security Protocols	VPN, SSL, and HTTPS	
Analog Outputs	0 to 20 mA or 0 to 10 V dc output Accuracy: 0.1% of full scale +0.01% per °C Resolution: 12 bit	
Discrete Output Rating (NMOS)	Less than 1 A max current at 30 V dc ON-state saturation: less than 0.7 V at 20 mA ON condition: Less than 0.7 V Off condition: Open	
Relay Outputs	One; output at 5 volts , 500 mA maximum	
Certifications		





Industrial Wireless Radios

Banner's network radios provide the backbone of a very flexible and highly expandable wireless network for industrial environments. Simple wire replacement products easily replace discrete, analog, Serial, and Ethernet signal wires with no setup software needed. The Performance Series centers around a Gateway and up to 47 remotely located Nodes with multiple I/O options. The MultiHop Series uses repeaters to extend the range of the network using multiple "hops" to cover larger distances or to circumvent obstacles (trees, buildings, topology, etc.).

Sure Cross[®] PM Series



An I/O Radio network that combines long range line-of-sight coverage with ease of deployment and use.

Banner's PM Series provides a flexible network that easily sets up without software. Setting up a basic point-to-point network is as easy as pairing a cell phone to a headset. You can replace cables and extend the range of digital and analog signals with minimum effort.

Key Features:

- Menu-driven LCD user interface
- No software needed
- IP67-rated housing for demanding environments
- One Gateway is preconfigured to support up to six Nodes
- Choose from two I/O configurations
- Select from multiple I/O maps

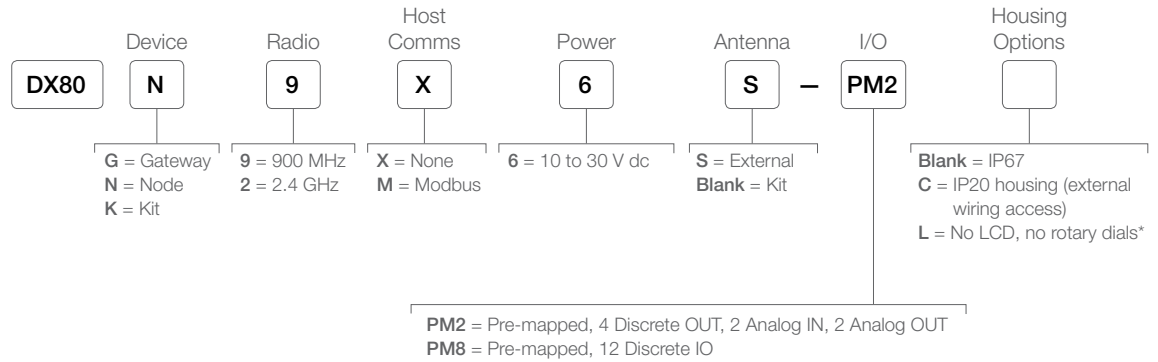

* Available on PM8 models only

Sure Cross[®] PM Kit



Simple wire replacement is even simpler with Banner's fully integrated kit.

Plug-and-play with one Gateway and one Node, pre-bound and mapped to solve your first wireless challenge, and provide the start of a flexible network that can be expanded as production needs change.

Key Features:

- Pre-bound and mapped expandable bi-directional radios
- Eight LCD menu selectable I/O mapping options
- IP67-rated housing for demanding environments
- One Gateway is preconfigured to support up to six Nodes

PM2 and PM8 Gateways and Nodes Specifications

Radio Range	900 MHz (1 W): Up to 9.6 kilometers (6 miles)* 2.4 GHz (65 mW): Up to 3.2 kilometers (2 miles)* <small>*Line of sight with included 2 dB antenna</small>	
Minimum Separation Distance	900 MHz (1 W): 4.57 m (15 ft)	2.4 GHz (65 mW): 0.3 m (1 ft)
Transmit Power	900 MHz (1 Watt): 30 dBm (1 W) conducted (up to 36 dBm EIRP)	2.4 GHz: 18 dBm (65 mW) conducted, less than or equal to 20 dBm (100 mW) EIRP
900 MHz Compliance	FCC ID UE3RM1809: This device complies with FCC Part 15, Subpart C, 15.247 IC: 7044A-RM1809	
2.4 GHz Compliance	FCC ID UE300DX80-2400 - This device complies with FCC Part 15, Subpart C, 15.247 ETSI/EN: In accordance with EN 300 328: V1.8.1 (2012-06) IC: 7044A-DX8024	
Spread Spectrum Technology	FHSS (Frequency Hopping Spread Spectrum)	
Linked Timeout	Gateway: Configurable via User Configuration Tool (UCT) software	Node: Defined by Gateway
Communication Hardware (RS-485) - Gateways Only	Interface: 2-wire half duplex RS-485 Baud rates: 9.6k, 19.2k (default), or 38.4k Data format: 8 data bits, no parity, 1 stop bit NOTE: Battery life is reduced to 1 year when the sample/report rate is increased to 16 seconds	
Communication Protocol	Modbus RTU	
Supply Voltage	10 to 30 V dc (Outside the USA: 12 to 24 V dc, $\pm 10\%$) 900 MHz Consumption: Maximum current draw is < 100 mA and typical current draw is < 50 mA at 24 V dc (2.4 GHz consumption is less)	
Construction	Polycarbonate housing and rotary dial cover; polyester labels; EDPM rubber cover gasket; nitrile rubber, non-sulphur cured button covers Weight: 0.26 kg (0.57 lbs) Mounting: #10 or M5 (SS M5 hardware included) Max. Tightening Torque: 0.56 N·m (5 lbf·in)	
Antenna Connection	Ext. Reverse Polarity SMA, 50 Ohms Max Tightening Torque: 0.45 N·m (4 lbf·in)	
Interface	Indicators: Two bi-color LEDs	Buttons: Two Display: Six character LCD
Wiring Access	Two 1/2-in NPT ports	
Environmental Rating	PM2 and PM8 Models: IEC IP67; NEMA 6	PM2C and PM8C Models: IP20; NEMA 1
Operating Conditions	Temperature: $-40\text{ }^{\circ}\text{C}$ to $+85\text{ }^{\circ}\text{C}$ ($-40\text{ }^{\circ}\text{F}$ to $+185\text{ }^{\circ}\text{F}$) (Electronics); $-20\text{ }^{\circ}\text{C}$ to $+80\text{ }^{\circ}\text{C}$ ($-4\text{ }^{\circ}\text{F}$ to $+176\text{ }^{\circ}\text{F}$) (LCD) Humidity: 95% max. relative (non-condensing) Radiated Immunity: 10 V/m, 80-2700 MHz (EN61000-4-3)	
Shock and Vibration	IEC 68-2-6 and IEC 68-2-27 Shock: 30g, 11 millisecond half sine wave, 18 shocks Vibration: 0.5 mm p-p, 10 to 60 Hz	

Certifications



Performance Board Modules

Sure Cross® Performance Embeddable Board Modules were specifically designed for the needs of industrial users to provide connectivity where traditional wired connections are not possible or cost prohibitive. Performance Embeddable Board Modules communicate with all Sure Cross Performance radios.

Key Features:

- Simple yet highly expandable
- Supports Point-to-Point and Star network topologies
- DIP switch mapping for up to two Nodes

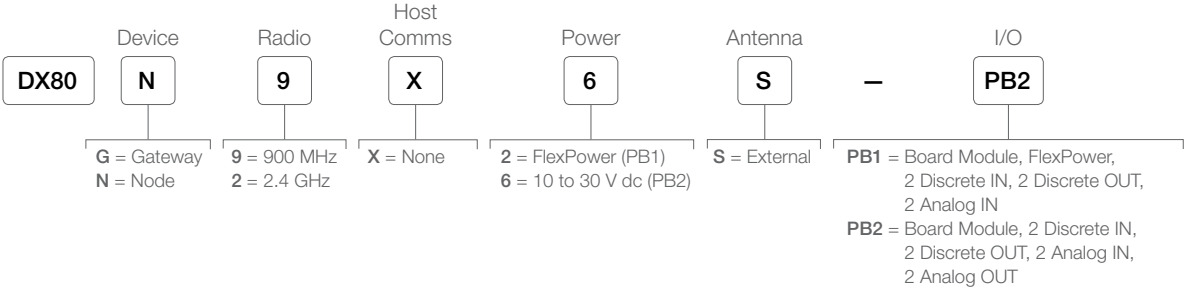

PB2 Gateway and Node Specifications

Radio Range	900 MHz (1 Watt): Up to 9.6 kilometers (6 miles)* 2.4 GHz (65 mW): Up to 3.2 kilometers (2 miles)* *Line of sight with included 2 dB antenna
Minimum Separation Distance	900 MHz (1 Watt): 4.57 m (15 ft) 2.4 GHz (65 mW): 0.3 m (1 ft)
Transmit Power	900 MHz (1 Watt): 30 dBm (1 W) conducted (up to 36 dBm EIRP) 2.4 GHz: 18 dBm (65 mW) conducted, less than or equal to 20 dBm (100 mW) EIRP
900 MHz Compliance	FCC ID UE3RM1809: This device complies with FCC Part 15, Subpart C, 15.247 IC: 7044A-RM1809
2.4 GHz Compliance	FCC ID UE300DX80-2400 - This device complies with FCC Part 15, Subpart C, 15.247 ETSI/EN: In accordance with EN 300 328: V1.8.1 (2012-06) IC: 7044A-DX8024
Spread Spectrum Technology	FHSS (Frequency Hopping Spread Spectrum)
Supply Voltage	10 to 30 V dc (Outside the USA: 12 to 24 V dc, $\pm 10\%$) 900 MHz Consumption: Maximum current draw is < 100 mA and typical current draw is < 50 mA at 24 V dc (2.4 GHz consumption is less)
Current Draw (at 24 V dc)	900 MHz, 1 Watt: Approx. 3.5 mA 900 MHz, 250 mW: Approx. 1.5 mA 2.4 GHz, 65 mW: Approx. 3.5 mA
Interface	Indicators: One bi-color LEDs Buttons: One
Wiring Access	Terminal block
Antenna Connection	Ext. Reverse Polarity SMA, 50 Ohms; Max Tightening Torque: 0.45 N-m (4 lbf-in) U.FL-R-SMT.(01); Use cable BWA-HW-030 (U.FL to RP-SMA) or the equivalent
Linked Timeout	Gateway: Configurable via User Configuration Tool (UCT) software Node: Defined by Gateway
Operating Conditions	Temperature: $-40\text{ }^{\circ}\text{C}$ to $+85\text{ }^{\circ}\text{C}$ ($-40\text{ }^{\circ}\text{F}$ to $+185\text{ }^{\circ}\text{F}$) Humidity: 95% max. relative (non-condensing)
Radiated Immunity	10 V/m, 80-2700 MHz (EN61000-4-3)

Serial Data Radio

Sure Cross® Multi-Hop Serial Data Radios are wireless industrial communication devices used to extend the range of Serial communication networks.

Key Features:

- DIP switches select operational modes: master, repeater or slave
- No software required for deployment
- Serial communication style (RS-232 or RS-485) is user-selectable

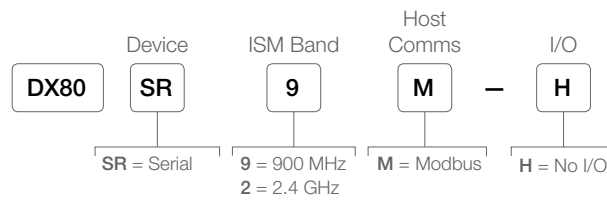

Serial Data Radio Specifications

Radio Range	900 MHz (1 Watt): Up to 9.6 kilometers (6 miles)* 2.4 GHz (65 mW): Up to 3.2 kilometers (2 miles)* *Line of sight with included 2 dB antenna
Minimum Separation Distance	900 MHz (1 Watt): 4.57 m (15 ft) 2.4 GHz (65 mW): 0.3 m (1 ft)
Transmit Power	900 MHz (1 Watt): 30 dBm (1 W) conducted (up to 36 dBm EIRP) 2.4 GHz: 18 dBm (65 mW) conducted, less than or equal to 20 dBm (100 mW) EIRP
900 MHz Compliance	FCC ID UE3RM1809: This device complies with FCC Part 15, Subpart C, 15.247 IC: 7044A-RM1809
2.4 GHz Compliance	FCC ID UE300DX80-2400 - This device complies with FCC Part 15, Subpart C, 15.247 ETSI/EN: In accordance with EN 300 328: V1.7.1 (2006-05) IC: 7044A-DX8024
Spread Spectrum Technology	FHSS (Frequency Hopping Spread Spectrum)
Supply Voltage	10 to 30 V dc (Outside the USA: 12 to 24 V dc, $\pm 10\%$)
Current Draw	Idle: At 30 V dc: 0.011 A At 24 V dc: 0.012 A At 10 V dc: 0.020 A Transmitting: At 30 V dc: 0.007 A At 24 V dc: 0.008 A At 10 V dc: 0.011 A
Housing	Polycarbonate housing and rotary dial cover; polyester labels; EDPM rubber cover gasket; nitrile rubber, non-sulphur cured button covers Weight: 0.26 kg (0.57 lbs) Mounting: #10 or M5 (SS M5 hardware included) Max. Tightening Torque: 0.56 N·m (5 lbf·in)
Interface	Indicators: Two bi-color LEDs Buttons: One (under small round cover)
Wiring Access	4-position terminal
Antenna Connection	Ext. Reverse Polarity SMA, 50 Ohms Max Tightening Torque: 0.45 N·m (4 lbf·in)
Hardware (Serial Data Radio SRxM-H)	Interface: 2-wire half-duplex RS-485 (default) or RS-232 Baud rates: 1200, 2400, 9600, 19.2k (default), 38.4k, 57.6k, 115.2k Data format: 8 data bits, 1 stop bit, no parity (default), even parity, odd parity
Packet Size (Serial Data Radio)	1500 bytes maximum
Wireless Data Transfer Rate	900 MHz: 300 kbps 2.4 GHz: 250 kbps
Environmental Rating	IEC IP67; NEMA 6
Operating Conditions	Operating Temperature: $-40\text{ }^{\circ}\text{C}$ to $+85\text{ }^{\circ}\text{C}$ ($-40\text{ }^{\circ}\text{F}$ to $+185\text{ }^{\circ}\text{F}$) (Electronics); $-20\text{ }^{\circ}\text{C}$ to $+80\text{ }^{\circ}\text{C}$ ($-4\text{ }^{\circ}\text{F}$ to $+176\text{ }^{\circ}\text{F}$) (LCD) Operating Humidity: 95% max. relative (non-condensing) Radiated Immunity: 10 V/m, 80-2700 MHz (EN61000-6-2)
Shock and Vibration	IEC 68-2-6 and IEC 68-2-27 Shock: 30g, 11 millisecond half sine wave, 18 shocks Vibration: 0.5 mm p-p, 10 to 60 Hz

Ethernet Data Radio



Sure Cross® Multi-Hop Ethernet Data Radios are wireless industrial communication devices used to create point-to-multipoint configurations of wireless Ethernet networks.

Key Features:

- No IP address configuration is required
- Self-healing, auto-routing RF network with multiple hops extends the network's range
- DIP switches select operational modes: master, repeater or slave
- Built-in site survey mode enables rapid assessment of a location's RF transmission properties

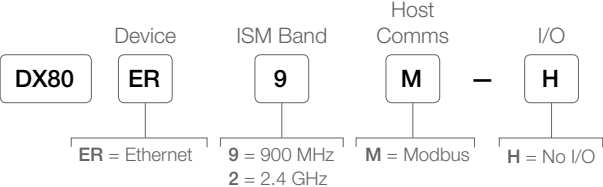

Ethernet Data Radio Specifications

Radio Range	900 MHz (1 Watt): Up to 9.6 kilometers (6 miles)* 2.4 GHz (65 mW): Up to 3.2 kilometers (2 miles)* *Line of sight with included 2 dB antenna
Transmit Power	900 MHz, 1 Watt: 30 dBm (1 W) conducted (up to 36 dBm EIRP) 2.4 GHz, 65 mW: 18 dBm (65 mW) conducted, less than or equal to 20 dBm (100 mW) EIRP
Receive Sensitivity	900 MHz: -104 dBm at 300 kbps; -107 dBm at 200 kbps; -108 dBm at 100 kbps 2.4 GHz: -104 dBm at 250 kbps
Minimum Separation Distance	900 MHz (1 Watt): 4.57 m (15 ft) 2.4 GHz (65 mW): 0.3 m (1 ft)
900 MHz Compliance	FCC ID UE3RM1809: This device complies with FCC Part 15, Subpart C, 15.247 IC: 7044A-RM1809
2.4 GHz Compliance	FCC ID UE300DX80-2400 - This device complies with FCC Part 15, Subpart C, 15.247 ETSI/EN: In accordance with EN 300 328: V1.7.1 (2006-05) IC: 7044A-DX8024
Spread Spectrum Technology	FHSS (Frequency Hopping Spread Spectrum)
Communication	Ethernet: 10/100 baseT Ethernet RJ45 connection Radio: 200kbps to 300kbps Encryption: AES (Advanced Encryption Standard) using a 256-bit cryptographic key
Supply Voltage	10 to 30 V dc (Outside the USA: 12 to 24 V dc, ±10%) on the brown wire, or 3.6 to 5.5 V dc low power option on the gray wire
Current Consumption	Idle: 50 mA at 24 V; 100 mA at 12 V; 170 mA at 5 V Transmit 250 mW: 60 mA at 24V ; 120 mA at 12 V; 200 mA at 5 V Transmit 1 Watt: 70 mA at 24 V; 130 mA at 12 V; 240 mA at 5 V
Housing	Polycarbonate housing and rotary dial cover; polyester labels; EDPM rubber cover gasket; nitrile rubber, non-sulphur cured button covers Weight: 0.26 kg (0.57 lbs) Mounting: #10 or M5 (SS M5 hardware included) Max. Tightening Torque: 0.56 N·m (5 lbf·in)
Antenna Connection	Ext. Reverse Polarity SMA, 50 Ohms Max Tightening Torque: 0.45 N·m (4 lbf·in)
Interface	Indicators: Two bi-color LEDs Buttons: Two Display: Six character LCD
Environmental Rating	IEC IP20; NEMA 1
Operating Conditions	-40 °C to +85 °C (-40 °F to +185 °F) (Electronics); -20 °C to +80 °C (-4 °F to +176 °F) (LCD) 95% maximum relative humidity (non-condensing) Radiated Immunity: 10 V/m (EN 61000-4-3)
Shock and Vibration	IEC 68-2-6 and IEC 68-2-27 Shock: 30g, 11 millisecond half sine wave, 18 shocks Vibration: 0.5 mm p-p, 10 to 60 Hz

DXER9 Ethernet Data Radio

Sure Cross® Ethernet Radio is an industrial grade, long range, 900 MHz radio used to create point-to-multipoint configurations of wireless Ethernet networks.

Key Features:

- DIP switches select operational modes
- FHSS radios operate and synchronize automatically
- RF transmission rate of 1.536 Mb/s and a throughput of 935 Kb/s
- 128 bit AES encryption for Ethernet data packets
- Point-to-multipoint configurations with up to 16 subscriber units

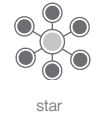

Models	Range	Transmit Range	Environmental Rating
DXER9	Up to 3 mile range	125 mW	IP55

Ethernet Data Radio Specifications

RF Transmission Rate	1.536 Mb/s
Ethernet Throughput	935 Kb/s
Output Power	+21 dBm (4 Watts EIRP used with 15 dBi antenna)
Receive Sensitivity	-97 dBm at 10e-4 BER (-112 dBm with 15 dBi antenna)
Radio Link Budget	148 dB with 15 dBi antenna
Range	Up to 3 miles
Radio Channels/Bandwidth	12 non-overlapping with 2.0833 MHz spacing and 1.75 MHz occupied bandwidth
Spread Spectrum Technology	Direct Sequence Spread Spectrum
Manual Frequency Select	Channel selected with DIP switch or via Web browser interface
Connector Types	Ext. Reverse Polarity SMA / 10-100 baseT Industrial Ethernet / 5-pin or 4-pin M12/Euro-style power connection
Status LEDs	Power, Ethernet Link, RF RX, RF TX, 4/Channel, and 6/Link Quality
Error Correction Technique	Sub-block error detection and retransmission
Adjacent-Band Rejection	SAW receiver filter attenuates cellular and pager interference
Regulator Type	Switching regulator
Browser Management Tools	QoS Statistics, Network Settings, Spectrum Analyzer, and Firmware Upgrading
Power Consumption	Transmit: 1.7 Watts Receive: 0.8 Watts
Voltage	Apply power using one of the following connections: Euro-style connector: 5 to 48 V dc with pin 1 positive and pin 3 ground
Temperature Range	-40 °C to 70 °C (-40 °F to +158 °F)
Mounting	#10 or M5 (M5 hardware included)
M5 Fasteners Max Tightening Torque	0.56 N·m (5 in-lbf)
Material	Case: PBT
Environmental Rating	IEC IP65; NEMA 4X
Certifications	 IND. CONT. EQ. 447Y <p>Maximum ambient temperature: 70 °C Power rating: UL Class 2 Enclosure environmental rating: UL Type 1</p>

Performance Series—Gateways



Create point-to-multipoint networks that distribute I/O over large areas. Input and output types include discrete (dry contact, PNP/NPN), analog (0 to 10 V dc, 0 to 20 mA), temperature (thermocouple and RTD), and pulse counter.

Key Features:

- Enhanced Gateways offer increased range in the 900 MHz frequency band
- High density I/O capacity provides up to 12 discrete inputs or outputs or a mix of discrete and analog I/O
- Universal analog inputs allow current or voltage to be selected in the field



DX80 Performance Gateways

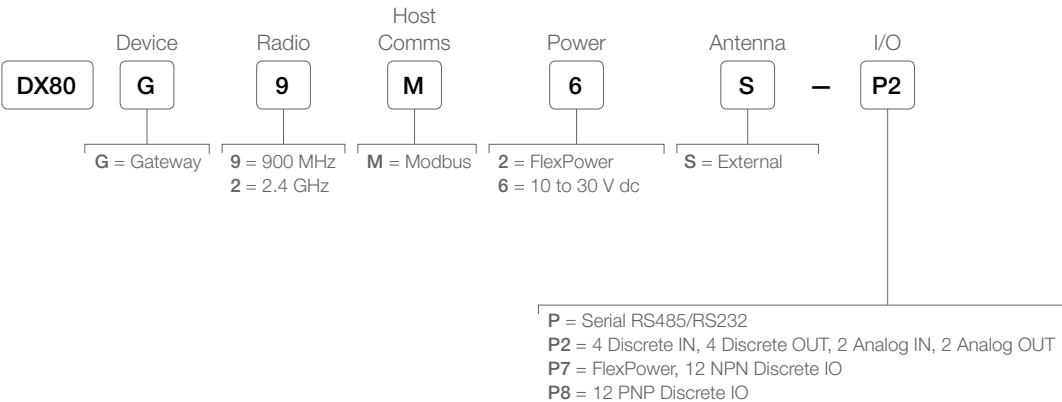

DX80 Performance Gateways, Board Models

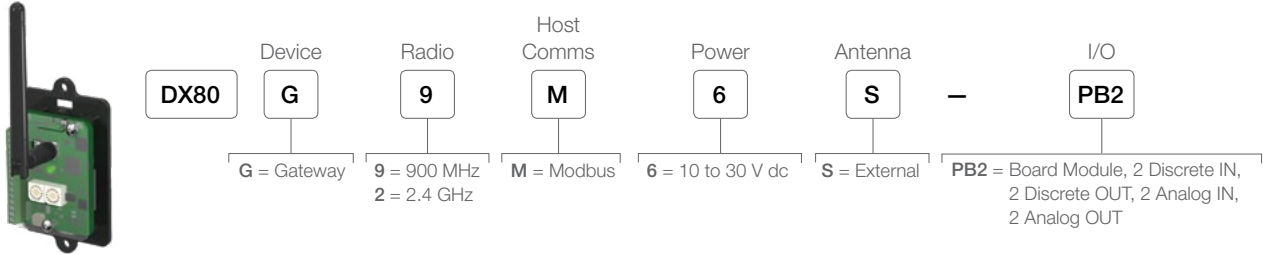

DX80 Performance Gateway Specifications*

Radio Range	900 MHz, 1 Watt: Up to 9.6 km (6 miles)	2.4 GHz, 65 mW: Up to 3.2 km (2 miles)		
Minimum Separation Distance	900 MHz, 1 Watt: 4.57 m (15 ft)	2.4 GHz, 65 mW: 0.3 m (1 ft)		
Radio Transmit Power	900 MHz, 1 Watt: 30 dBm (1 W) conducted (up to 36 dBm EIRP)	2.4 GHz, 65 mW: 18 dBm (65 mW) conducted, less than or equal to 20 dBm (100 mW) EIRP		
Compliance	900 MHz Compliance (1 Watt) FCC ID UE3RM1809: This device complies with FCC Part 15, Subpart C, 15.247 IC: 7044A-RM1809	2.4 GHz Compliance FCC ID UE300DX80-2400 - This device complies with FCC Part 15, Subpart C, 15.247 ETSI/EN: In accordance with EN 300 328: V1.8.1 (2012-06) IC: 7044A-DX8024		
Spread Spectrum Technology	FHSS (Frequency Hopping Spread Spectrum)			
Communication Hardware	Interface: 2-wire half-duplex RS-485 Baud rates: 9.6k, 19.2k (default), or 38.4k via DIP switches Data format: 8 data bits, no parity, 1 stop bit			
Communication Protocol	Modbus RTU			
Link Timeout	Gateway: Configurable via User Configuration Tool (UCT) software Node: Defined by Gateway			
RTD Inputs	Sample Rate: 1 second	Report Rate: 16 seconds	Accuracy: 0.1% of full scale	Resolution: 0.1 °C, 15-bit
Operating Conditions	-40 °C to +85 °C (-40 °F to +185 °F) (Electronics); -20 °C to +80 °C (-4 °F to +176 °F) (LCD) 95% maximum relative humidity (non-condensing) Radiated Immunity: 10 V/m (EN 61000-4-3)			
Shock and Vibration	IEC 68-2-6 and IEC 68-2-27	Shock: 30g, 11 millisecond half sine wave, 18 shocks	Vibration: 0.5 mm p-p, 10 to 60 Hz	
Supply Voltage	DX80 and "C" Housing Models: 10 to 30 V dc or 3.6 to 5.5 V dc low power option (Outside the USA: 12 to 24 V dc, ±10% or 3.6 to 5.5 V dc low power option) 900 MHz Consumption: Maximum current draw is < 40 mA and typical current draw is < 30 mA at 24 V dc. (2.4 GHz consumption is less)			
Construction	Polycarbonate housing and rotary dial cover; polyester labels; EDPM rubber cover gasket; nitrile rubber, non-sulphur cured button covers Weight: 0.26 kg (0.57 lbs) DX80 and "C" Housing Models: Mounting: #10 or M5 (SS M5 hardware included) Max. Tightening Torque: 0.56 N·m (5 lbf·in)			
Antenna Connection	Ext. Reverse Polarity SMA, 50 Ohms	Max Tightening Torque: 0.45 N·m (4 lbf·in)		
Interface	Indicators: Two bi-color LEDs	Buttons: Two	Display: Six character LCD	
Wiring Access	DX80 Housing Models: Four PG-7, One 1/2-in NPT, One 5-pin threaded M12/Euro-style male quick-disconnect "C" Housing Models: External terminals			
Environmental Rating	DX80 models: IEC IP67; NEMA 6 "C" Housing Models: IEC IP20; NEMA 1			
Certifications				

* See datasheet for model specific details

Performance Series—Nodes



Create point-to-multipoint networks that distribute I/O over large areas. Input and output types include discrete (dry contact, PNP/NPN), analog (0 to 10 V dc, 0 to 20 mA), temperature (thermocouple and RTD), and pulse counter.

Key Features:

- Enhanced Nodes offer increased range in the 900 MHz frequency band
- High density I/O capacity provides up to 12 discrete inputs or outputs or a mix of discrete and analog I/O
- Universal analog inputs allow current or voltage to be selected in the field



DX80 Performance Nodes

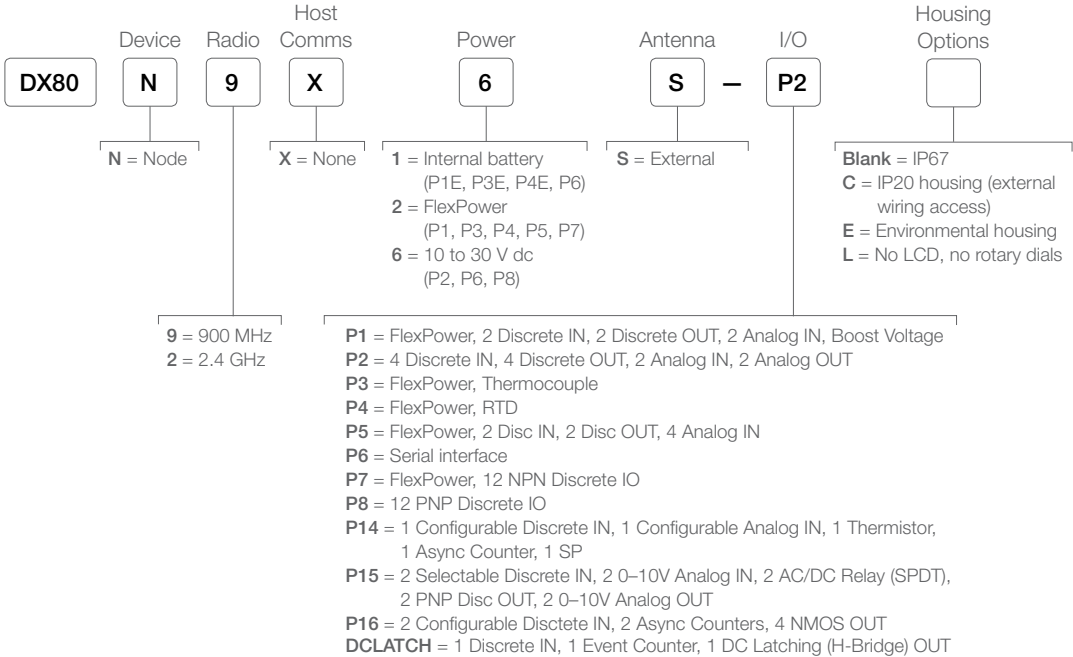

DX80 Performance Nodes, Board Models

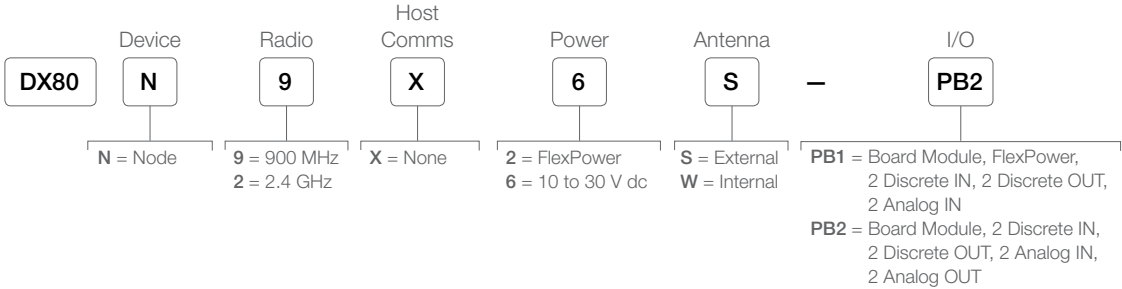

DX80 Performance Nodes Specifications*

Radio Range	900 MHz, 1 Watt: Up to 9.6 km (6 miles)	2.4 GHz, 65 mW: Up to 3.2 km (2 miles)
Minimum Separation Distance	900 MHz, 1 Watt: 4.57 m (15 ft)	2.4 GHz, 65 mW: 0.3 m (1 ft)
Radio Transmit Power	900 MHz, 1 Watt: 30 dBm (1 W) conducted (up to 36 dBm EIRP)	2.4 GHz, 65 mW: 18 dBm (65 mW) conducted, less than or equal to 20 dBm (100 mW) EIRP
Compliance	900 MHz Compliance (1 Watt) FCC ID UE3RM1809: This device complies with FCC Part 15, Subpart C, 15.247 IC: 7044A-RM1809	2.4 GHz Compliance FCC ID UE300DX80-2400 - This device complies with FCC Part 15, Subpart C, 15.247 ETSI/EN: In accordance with EN 300 328: V1.8.1 (2012-06) IC: 7044A-DX8024
Spread Spectrum Technology	FHSS (Frequency Hopping Spread Spectrum)	
Link Timeout	Gateway: Configurable via User Configuration Tool (UCT) software Node: Defined by Gateway	
Operating Conditions	-40 °C to +85 °C (-40 °F to +185 °F) (Electronics); -20 °C to +80 °C (-4 °F to +176 °F) (LCD) "E" Housing Models: -40 °C to +65 °C (-40 °F to +149 °F) (Electronics); -20 °C to +80 °C (-4 °F to +176 °F) (LCD) 95% maximum relative humidity (non-condensing) Radiated Immunity: 10 V/m (EN 61000-4-3)	
Shock and Vibration	IEC 68-2-6 and IEC 68-2-27	Shock: 30g, 11 millisecond half sine wave, 18 shocks Vibration: 0.5 mm p-p, 10 to 60 Hz
Supply Voltage	DX80 and "C" Housing Models: 10 to 30 V dc or 3.6 to 5.5 V dc low power option (Outside the USA: 12 to 24 V dc, ±10% or 3.6 to 5.5 V dc low power option) "E" Housing Models: 3.6 V dc low power option from an internal battery or 10 to 30 V dc 900 MHz Consumption: Maximum current draw is < 40 mA and typical current draw is < 30 mA at 24 V dc. (2.4 GHz consumption is less)	
Construction	Polycarbonate housing and rotary dial cover; polyester labels; EDPM rubber cover gasket; nitrile rubber, non-sulphur cured button covers Weight: 0.26 kg (0.57 lbs) DX80 and "C" Housing Models: Mounting: #10 or M5 (SS M5 hardware included) "E" Housing Models: Mounting: 1/4-in or M7 (SS M7 hardware included) Max. Tightening Torque: 0.56 N-m (5 lbf-in)	
Antenna Connection	Ext. Reverse Polarity SMA, 50 Ohms	Max Tightening Torque: 0.45 N-m (4 lbf-in)
Interface	Indicators: Two bi-color LEDs	Buttons: Two Display: Six character LCD
Wiring Access	DX80 Housing Models: Four PG-7, One 1/2-in NPT, One 5-pin threaded M12/Euro-style male quick-disconnect "C" Housing Models: External terminals "E" Housing Models: Two 1/2-in NPT	
Environmental Ratingw	DX80 models: IEC IP67; NEMA 6 "C" Housing Models: IEC IP20; NEMA 1 "E" Housing Models: IEC IP65; NEMA 4X	
Certifications		

* See datasheet for model specific details

Performance Series–P6 Nodes



The -P6 Performance Node is an industrial radio device with a 1-wire Serial Interface that is designed to transmit data from 1-wire Serial sensors, such as the Banner Temperature and Humidity (M12FTH4Q), Vibration and Temperature (QM42VT1), or Ultrasonic (K50UX1RA) sensors.

Key Features:

- 1-wire Serial Interface
- Battery-powered models for a completely wireless solution
- Line-powered models for continuous sampling

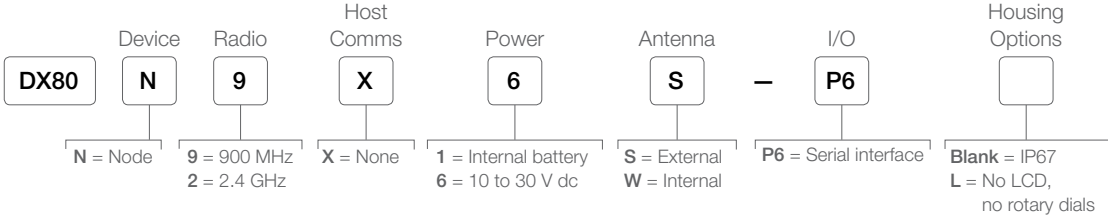

Used with		
M12FTH4Q	Temperature and relative humidity via a 1-wire Serial Interface	see page 6
M12FT4Q	Temperature via a 1-wire Serial Interface	see page 6
QM42VT1	Vibration and temperature via a 1-wire Serial Interface	see page 10
K50UX1RA	Ultrasonic sensor with a 1-wire Serial Interface	see page 12

DX80 Performance P6 Specifications

Radio Range	900 MHz, 1 Watt: Up to 9.6 km (6 miles)	2.4 GHz, 65 mW: Up to 3.2 km (2 miles)
Minimum Separation Distance	900 MHz, 1 Watt: 4.57 m (15 ft)	2.4 GHz, 65 mW: 0.3 m (1 ft)
Radio Transmit Power	900 MHz, 1 Watt: 30 dBm (1 W) conducted (up to 36 dBm EIRP)	2.4 GHz, 65 mW: 18 dBm (65 mW) conducted, less than or equal to 20 dBm (100 mW) EIRP
Compliance	900 MHz Compliance (1 Watt) FCC ID UE3RM1809: This device complies with FCC Part 15, Subpart C, 15.247 IC: 7044A-RM1809	2.4 GHz Compliance FCC ID UE300DX80-2400 - This device complies with FCC Part 15, Subpart C, 15.247 ETSI/EN: In accordance with EN 300 328: V1.8.1 (2012-06) IC: 7044A-DX8024
Spread Spectrum Technology	FHSS (Frequency Hopping Spread Spectrum)	
Link Timeout	Gateway: Configurable via User Configuration Tool (UCT) software Node: Defined by Gateway	
Operating Conditions	-40 °C to +85 °C (-40 °F to +185 °F) (Electronics); -20 °C to +80 °C (-4 °F to +176 °F) (LCD) 95% maximum relative humidity (non-condensing) Radiated Immunity: 10 V/m (EN 61000-4-3)	
Shock and Vibration	IEC 68-2-6 and IEC 68-2-27	Shock: 30g, 11 millisecond half sine wave, 18 shocks Vibration: 0.5 mm p-p, 10 to 60 Hz
Supply Voltage	Integrated battery models: 3.6 V dc low power option from an internal battery Non-battery models: 10 to 30 V dc (Outside the USA: 12 to 24 V dc, ±10%)	
Construction	Polycarbonate housing and rotary dial cover; polyester labels; EDPM rubber cover gasket; nitrile rubber, non-sulphur cured button covers Integrated battery models: Weight: 0.30 kg (0.65 lbs) Non-battery models: Weight: 0.26 kg (0.57 lbs) Mounting: #10 or M5 (SS M5 hardware included) Max. Tightening Torque: 0.56 N-m (5 lbf-in)	
Antenna Connection	Ext. Reverse Polarity SMA, 50 Ohms	Max Tightening Torque: 0.45 N-m (4 lbf-in)
Interface	Indicators: Two bi-color LEDs	Buttons: Two Display: Six character LCD
Wiring Access	Integrated battery models: One 5-pin threaded M12 Euro-style female quick-disconnect Non-battery models: One 5-pin threaded M12 Euro-style female quick-disconnect and one 5-pin threaded M12 Euro-style male quick-disconnect	
Environmental Rating	IEC IP67; NEMA 6	
Certifications		

Performance Series-P14 Nodes



The -P14 Performance Node is an industrial radio device that makes it easy to add a remote monitoring point to a wireless network. Simply select one I/O from multiple options, then wire a sensor into the easily accessible wiring terminals inside the Node. The integrated D-cell lithium battery makes it easy to deploy, even where power is not readily available.

Key Features:

- Inputs include: One configurable discrete, one configurable analog, one thermistor, one asynchronous counter
- Battery-powered models for a completely wireless solution
- Field-wireable terminal for wiring I/O

Applications:

- Door monitoring
- Tank level monitoring
- High speed counting
- Flow monitoring
- RPM monitoring
- Non-contact temperature monitoring
- Pressure monitoring

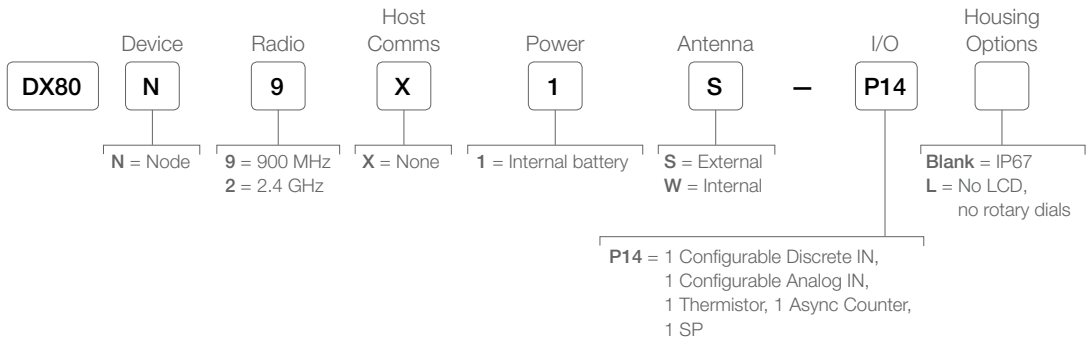

Used with		
T30UX	Long-range ultrasonic sensor	see bannerengineering.com
QT50ULB	Long-range ultrasonic sensor	see bannerengineering.com
M18T	Non-contact temperature sensor	see bannerengineering.com
TL70	Wireless modular tower light	see page 22

DX80 Performance P14 Specifications

Radio Range	900 MHz, 1 Watt: Up to 9.6 km (6 miles)	2.4 GHz, 65 mW: Up to 3.2 km (2 miles)
Minimum Separation Distance	900 MHz, 1 Watt: 4.57 m (15 ft)	2.4 GHz, 65 mW: 0.3 m (1 ft)
Radio Transmit Power	900 MHz, 1 Watt: 30 dBm (1 W) conducted (up to 36 dBm EIRP)	2.4 GHz, 65 mW: 18 dBm (65 mW) conducted, less than or equal to 20 dBm (100 mW) EIRP
Compliance	900 MHz Compliance (1 Watt) FCC ID UE3RM1809: This device complies with FCC Part 15, Subpart C, 15.247 IC: 7044A-RM1809	2.4 GHz Compliance FCC ID UE300DX80-2400 - This device complies with FCC Part 15, Subpart C, 15.247 ETSI/EN: In accordance with EN 300 328: V1.8.1 (2012-06) IC: 7044A-DX8024
Spread Spectrum Technology	FHSS (Frequency Hopping Spread Spectrum)	
Link Timeout	Gateway: Configurable via User Configuration Tool (UCT) software Node: Defined by Gateway	
Operating Conditions	-40 to +85 °C (-40 to +185 °F) (Electronics); -20 to +80 °C (-4 to +176 °F) (LCD) 95% maximum relative humidity (non-condensing) Radiated Immunity: 10 V/m (EN 61000-4-3)	
Shock and Vibration	IEC 68-2-6 and IEC 68-2-27 Shock: 30g, 11 millisecond half sine wave, 18 shocks	Vibration: 0.5 mm p-p, 10 to 60 Hz
Discrete Input	Rating: 3 mA max current at 30 V dc Sample / Report Rates: DIP switch configurable	
Discrete Input ON Condition	PNP: Greater than 8 V NPN: Less than 0.7 V	
Discrete Input OFF Condition	PNP: Less than 5 V NPN: Greater than 2 V or open	
Supply Voltage	3.6 V dc low power option from an internal battery	
Construction	Polycarbonate housing and rotary dial cover; polyester labels; EDPM rubber cover gasket; nitrile rubber, non-sulphur cured button covers Integrated battery models: Weight: 0.30 kg (0.65 lbs) Non-battery models: Weight: 0.26 kg (0.57 lbs) Mounting: #10 or M5 (SS M5 hardware included) Max. Tightening Torque: 0.56 N-m (5 lbf-in)	
Antenna Connection	Ext. Reverse Polarity SMA, 50 Ohms	Max Tightening Torque: 0.45 N-m (4 lbf-in)
Interface	Indicators: Two bi-color LEDs	Buttons: Two Display: Six character LCD
Wiring Access	Two 1/2-inch NPT	
Switch Power Outputs	Analog configuration: one (SP1) Discrete configuration: one (SP1)	
Thermistor Input	Model: 44006, 44016, or 44031 Series of 10 kOhm thermistors Sample Rate: 16 seconds Report Rate: 64 seconds Accuracy: 0.4 °C (10 °C to 50 °C); Up to 0.8 °C (-40 °C to 85 °C)	
Counter Input	Event counter: Input rating 1 Hz to 10 kHz (For battery powered devices, the recommended input rating is less than 1 kHz) Rate (frequency) counter: 1 Hz to 10 kHz Threshold: 1.7 V	
Environmental Rating	IEC IP67; NEMA 6	
Certifications		



Performance Series–P15E Nodes

The P15E Performance Node enables users to wirelessly power and control any connected devices and easily monitor device status and performance. It is easy to deploy and a simple way to remotely control lights, fans, motors, and other AC-powered devices without the trouble or expense of running cable.

Key Features:

- Switch AC loads up to 10 amps
- AC-power field-wireable
- No separate power supply required
- Supply voltage of 100 to 277 V AC at 50/60 Hz

Applications:

- Remotely control lights, dimming levels, fans, and motors
- Provide power and control connectivity to remote I/O devices

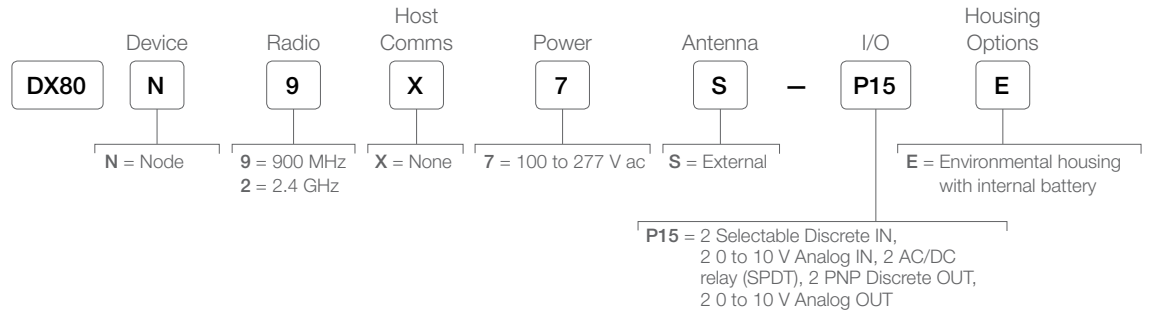

Used with

WLB92ZC1100ACT	Large, ultra-bright LED work light	
WLB32ZC1130QM	Adjustable LED workstation light	see bannerengineering.com
K50LGRYA120Q	50 mm colored domed indicator	

DX80 Performance -P15E Specifications

Radio Range	900 MHz, 1 Watt: Up to 9.6 km (6 miles)	2.4 GHz, 65 mW: Up to 3.2 km (2 miles)
Minimum Separation Distance	900 MHz, 1 Watt: 4.57 m (15 ft)	2.4 GHz, 65 mW: 0.3 m (1 ft)
Radio Transmit Power	900 MHz, 1 Watt: 30 dBm (1 W) conducted (up to 36 dBm EIRP)	2.4 GHz, 65 mW: 18 dBm (65 mW) conducted, less than or equal to 20 dBm (100 mW) EIRP
Compliance	900 MHz Compliance (1 Watt) FCC ID UE3RM1809: This device complies with FCC Part 15, Subpart C, 15.247 IC: 7044A-RM1809	2.4 GHz Compliance FCC ID UE300DX80-2400 - This device complies with FCC Part 15, Subpart C, 15.247 ETSI/EN: In accordance with EN 300 328: V1.8.1 (2012-06) IC: 7044A-DX8024
Spread Spectrum Technology	FHSS (Frequency Hopping Spread Spectrum)	
Antenna Connection	Ext. Reverse Polarity SMA, 50 Ohms Max Tightening Torque: 0.45 N-m (4 lbf-in)	
Link Timeout	Gateway: Configurable via User Configuration Tool (UCT) software Node: Defined by Gateway	
Supply Voltage	Nominal voltage: 120–277 V ac at 60 Hz in North America Nominal voltage: 100–277 V ac at 50/60 Hz outside North America Maximum supply current: 0.37 A Maximum power consumption: 25 W	
Interface	Indicators: Two bi-color LEDs Buttons: Two Display: Six character LCD	
Construction	Polycarbonate housing and rotary dial cover; polyester labels; EDPM rubber cover gasket; nitrile rubber, non-sulphur cured button covers Weight: 0.51 kg (1.13 lbs) Mounting: 1/4-inch or M7 Max. Tightening Torque: 0.56 N-m (5 lbf-in)	
Wiring Access	Two 1/2-inch NPSM ports, 14 threads/inch (1/2-14 NPSM)	
Analog Input	0 to 10 V Input Rating: 10 V Impedance: Approximately 220 Ohms Sample Rate: 62.5 milliseconds Report Rate: 1 second or On Change of State (1% change in value) Accuracy: 0.2% of full scale +0.01% per °C Resolution: 12-bit	
Output State Following Timeout	De-energized (OFF)	
Relay Outputs	SPDT (Form C) relay 277 V ac, 10 A Minimum Mechanical Life: 10,000,000 Surge breakdown voltage (Between contacts and coil) (Initial): 10,000 V	
Analog Output	0 to 10 V Update Rate: 125 milliseconds Accuracy: 1.0% of full scale +0.01% per °C Resolution: 12-bit	
Shock and Vibration	IEC 68-2-6 and IEC 68-2-27 Shock: 30g, 11 millisecond half sine wave, 18 shocks Vibration: 0.5 mm p-p, 10 to 60 Hz	
Operating Conditions	–40 °C to +85 °C (–40 °F to +185 °F) (Electronics); –20 °C to +80 °C (–4 °F to +176 °F) (LCD) 95% maximum relative humidity (non-condensing) Radiated Immunity: 10 V/m (EN 61000-4-3)	
Environmental Rating	IEC IP65	
Certifications	 	

MultiHop Modbus Radios



MultiHop Modbus Data Radios extend the range of Modbus or other Serial communication networks. Each radio may be set to act as either a master, repeater or slave. Models are available with built in discrete and analog I/O, which can be accessed using the Modbus protocol.

Key Features:

- Self-healing, auto routing RF network with multiple hops extends the network’s range
- Flexible: DIP switch selectable to be a master, repeater or slave
- User-selectable communication between RS-485 and RS-232

MultiHop Modbus Radios

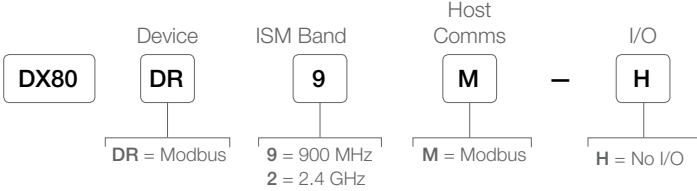

MultiHop Modbus Radios with I/O

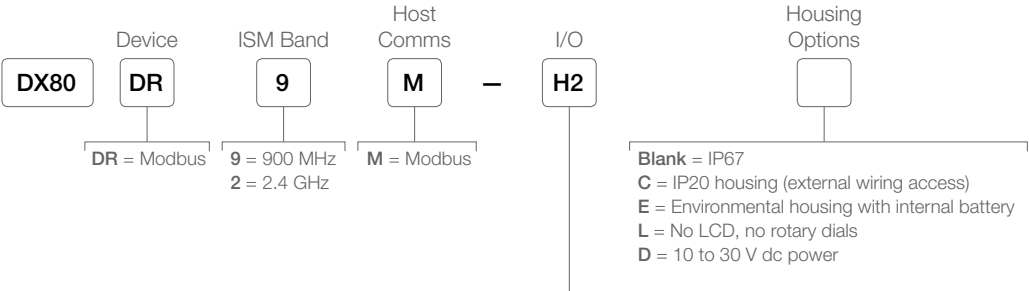

- H1** = FlexPower, 4 Discrete IN, 2 Discrete OUT, 4 Analog IN, 1 thermistor IN, 1 Counter IN
- H2** = 4 Discrete IN, 4 Discrete OUT, 2 Analog IN, 2 Analog OUT
- H3** = FlexPower, Thermocouple
- H4** = FlexPower, RTD
- H5** = FlexPower, 4 Discrete IN, 2 Discrete OUT, 4 Analog IN
- H6** = Serial interface H12 = FlexPower, SDI-12, Bridge, Counter, Discrete, Analog
- H12** = FlexPower, SDI-12, Bridge, Counter, Discrete, Analog
- H14** = 1 Configurable Discrete IN, 1 Configurable Analog IN, 1 Thermistor, 1 SDI-12, 1 Async Counter, 1 SP
- H15** = 2 PNP Discrete IN, 2 0 to 20 mA Analog IN, 2 AC/DC Relay (SPDT), 2 PNP Discrete OUT, 2 0 to 10 V Analog OUT
- DCLATCH** = 2 Discrete IN, 2 Event Counters, 1 DC Latching (H-Bridge) OUT

MultiHop Modbus Radios with I/O — Board Models

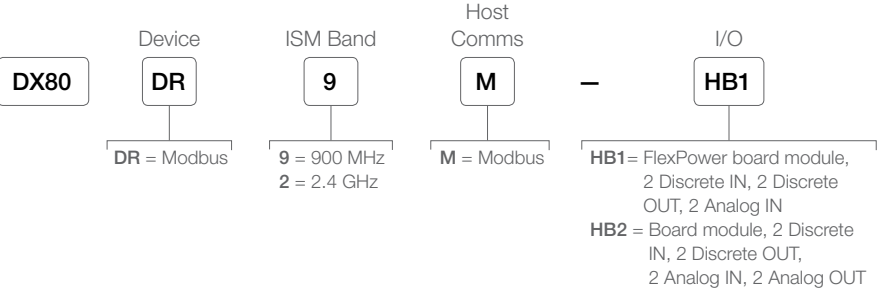

MultiHop Modbus Radios with I/O Specifications*

Radio Range	900 MHz, 1 Watt: Up to 9.6 km (6 miles)	2.4 GHz, 65 mW: Up to 3.2 km (2 miles)
Minimum Separation Distance	900 MHz, 1 Watt: 4.57 m (15 ft)	2.4 GHz, 65 mW: 0.3 m (1 ft)
Radio Transmit Power	900 MHz, 1 Watt: 30 dBm (1 W) conducted (up to 36 dBm EIRP)	2.4 GHz, 65 mW: 18 dBm (65 mW) conducted, less than or equal to 20 dBm (100 mW) EIRP
Power	<p><i>FlexPower</i> models: 10 to 30 V dc (Outside the USA: 12 to 24 V dc, $\pm 10\%$) on the brown wire, or 3.6 to 5.5 V dc low power option on the gray wire 6</p> <p>Integrated battery models: 3.6 V dc low power option from an internal battery or 10 to 30 V dc</p> <p>Master radio consumption (900 MHz): Maximum current draw is < 100 mA and typical current draw is < 30 mA at 24 V dc (2.4 GHz consumption is less)</p> <p>Repeater/slave radio consumption (900 MHz): Maximum current draw is < 40 mA and typical current draw is < 20 mA at 24 V dc (2.4 GHz consumption is less)</p>	
Compliance	<p>900 MHz Compliance (1 Watt)</p> <p>FCC ID UE3RM1809: This device complies with FCC Part 15, Subpart C, 15.247</p> <p>IC: 7044A-RM1809</p>	<p>2.4 GHz Compliance</p> <p>FCC ID UE300DX80-2400 - This device complies with FCC Part 15, Subpart C, 15.247</p> <p>ETSI/EN: In accordance with EN 300 328: V1.8.1 (2012-04)</p> <p>IC: 7044A-DX8024</p>
Spread Spectrum Technology	FHSS (Frequency Hopping Spread Spectrum)	
Antenna Connection	Ext. Reverse Polarity SMA, 50 Ohms	Max Tightening Torque: 0.45 N-m (4 lbf-in)
Interface	Indicators: Two bi-color LEDs	Buttons: Two Display: Six character LCD
Communication Hardware (MultiHop RS-485)	<p>Interface: 2-wire half-duplex RS-485</p> <p>Baud rates: 9.6k, 19.2k (default), or 38.4k via DIP switches; 1200 and 2400 via the MultiHop Configuration Tool</p> <p>Data format: 8 data bits, no parity, 1 stop bit</p>	
Packet Size (MultiHop)	900 MHz: 175 bytes (85 Modbus registers)	2.4 GHz: 75 bytes (37 Modbus registers)
Intercharacter Timing (MultiHop)	3.5 milliseconds	
Housing	<p>Polycarbonate housing and rotary dial cover; polyester labels; EDPM rubber cover gasket; nitrile rubber, non-sulphur cured button covers</p> <p>Weight: 0.26 kg (0.57 lbs)</p> <p>M-Hx and M-HxC models: Mounting: #10 or M5 (SS M5 hardware included)</p> <p>M-HxE models: Mounting: 1/4-in or M7 (SS M7 hardware included)</p> <p>Max. Tightening Torque: 0.56 N-m (5 lbf-in)</p>	
Wiring Access	<p>M-Hx models: Four PG-7, One 1/2-in NPT, One 5-pin threaded M12/Euro-style male quick-disconnect</p> <p>M-HxC models: External terminals</p> <p>M-HxE models: Two 1/2-in NPT ports</p>	
Environmental Rating	<p>M-Hx: IEC IP67; NEMA 6</p> <p>"C" Housing Models: IEC IP20; NEMA 1</p> <p>"E" Housing Models: IEC IP65; NEMA 4X</p>	
Operating Conditions	<p>M-Hx and M-HxC models: $-40\text{ }^{\circ}\text{C}$ to $+85\text{ }^{\circ}\text{C}$ ($-40\text{ }^{\circ}\text{F}$ to $+185\text{ }^{\circ}\text{F}$) (Electronics); $-20\text{ }^{\circ}\text{C}$ to $+80\text{ }^{\circ}\text{C}$ ($-4\text{ }^{\circ}\text{F}$ to $+176\text{ }^{\circ}\text{F}$) (LCD)</p> <p>M-HxE models: $-40\text{ }^{\circ}\text{C}$ to $+65\text{ }^{\circ}\text{C}$ ($-40\text{ }^{\circ}\text{F}$ to $+149\text{ }^{\circ}\text{F}$) (Electronics); $-20\text{ }^{\circ}\text{C}$ to $+80\text{ }^{\circ}\text{C}$ ($-4\text{ }^{\circ}\text{F}$ to $+176\text{ }^{\circ}\text{F}$) (LCD)</p> <p>95% maximum relative humidity (non-condensing)</p> <p>Radiated Immunity: 10 V/m (EN 61000-4-3)</p>	
Shock and Vibration	<p>IEC 68-2-6 and IEC 68-2-27</p> <p>Shock: 30g, 11 millisecond half sine wave, 18 shocks</p> <p>Vibration: 0.5 mm p-p, 10 to 60 Hz</p>	
Certifications		

* See datasheet for model specific details

MultiHop Modbus-H6



The -H6 MultiHop Modbus Data Radio has a 1-wire Serial Interface that is designed to transmit data from 1-wire Serial sensors, such as the Banner Temperature and Humidity (M12FTH4Q), Vibration and Temperature (QM42VT1), or Ultrasonic (K50UX1RA) sensors.

Key Features:

- 1-wire Serial Interface
- Battery-powered models for a completely wireless solution
- Tree topology allows for multiple hops to cover longer distances and circumvent obstacles

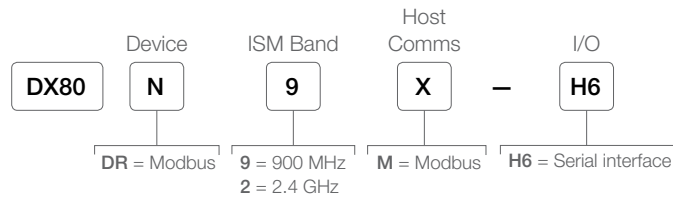

Used with

M12FTH4Q	Temperature and relative humidity via a 1-wire Serial Interface	see page 6
M12FT4Q	Temperature via a 1-wire Serial Interface	
QM42VT1	Vibration and temperature via a 1-wire Serial Interface	see page 10
K50UX1RA	Ultrasonic sensor with a 1-wire Serial Interface	see page 12

MultiHop -H6 Modbus Radio Specifications

Radio Range	900 MHz, 1 Watt: Up to 9.6 km (6 miles)	2.4 GHz, 65 mW: Up to 3.2 km (2 miles)
Minimum Separation Distance	900 MHz, 1 Watt: 4.57 m (15 ft)	2.4 GHz, 65 mW: 0.3 m (1 ft)
Radio Transmit Power	900 MHz, 1 Watt: 30 dBm (1 W) conducted (up to 36 dBm EIRP)	2.4 GHz, 65 mW: 18 dBm (65 mW) conducted, less than or equal to 20 dBm (100 mW) EIRP
Supply Voltage	3.6 V dc low power option from an internal battery	
Compliance	900 MHz Compliance (1 Watt) FCC ID UE3RM1809: This device complies with FCC Part 15, Subpart C, 15.247 IC: 7044A-RM1809	2.4 GHz Compliance FCC ID UE300DX80-2400 - This device complies with FCC Part 15, Subpart C, 15.247 ETSI/EN: In accordance with EN 300 328: V1.8.1 (2012-04) IC: 7044A-DX8024
Spread Spectrum Technology	FHSS (Frequency Hopping Spread Spectrum)	
Antenna Connection	Ext. Reverse Polarity SMA, 50 Ohms	Max Tightening Torque: 0.45 N-m (4 lbf-in)
Interface	Indicators: Two bi-color LEDs	Buttons: Two Display: Six character LCD
Communication Hardware (MultiHop RS-485)	Interface: 2-wire half-duplex RS-485 Baud rates: 9.6k, 19.2k (default), or 38.4k via DIP switches; 1200 and 2400 via the MultiHop Configuration Tool Data format: 8 data bits, no parity, 1 stop bit	
Packet Size (MultiHop)	900 MHz: 175 bytes (85 Modbus registers)	2.4 GHz: 75 bytes (37 Modbus registers)
Intercharacter Timing (MultiHop)	3.5 milliseconds	
Housing	Polycarbonate housing and rotary dial cover; polyester labels; EDPM rubber cover gasket; nitrile rubber, non-sulphur cured button covers Weight: 0.26 kg (0.57 lbs) Mounting: #10 or M5 (SS M5 hardware included) Max. Tightening Torque: 0.56 N-m (5 lbf-in)	
Wiring Access	One 5-pin threaded M12/Euro-style male quick-disconnect	
Environmental Rating	IEC IP67; NEMA 6	
Operating Conditions	-40 °C to +65 °C (-40 °F to +149 °F) (Electronics); -20 °C to +80 °C (-4 °F to +176 °F) (LCD) 95% maximum relative humidity (non-condensing) Radiated Immunity: 10 V/m (EN 61000-4-3)	
Shock and Vibration	IEC 68-2-6 and IEC 68-2-27 Shock: 30g, 11 millisecond half sine wave, 18 shocks Vibration: 0.5 mm p-p, 10 to 60 Hz	
Certifications		

MultiHop Modbus-H14

The -H14 Multi-Hop Modbus Data Radio makes it easy to add a remote monitoring point to a wireless network. Simply select one I/O from multiple options, then wire a sensor into the easily accessible wiring terminals inside the Node. The integrated D-cell lithium battery makes it easy to deploy, even where power is not readily available.



Key Features:

- Inputs include: One configurable discrete, one configurable analog, one thermistor, one asynchronous counter, and one SDI-12
- Battery-powered models for a completely wireless solution
- Tree topology allows for multiple hops to cover longer distances and circumvent obstacles
- Field-wireable terminal for wiring I/O

Applications:

- Door monitoring
- Tank level monitoring
- High speed counting
- Flow monitoring
- RPM monitoring
- Non-contact temperature monitoring
- Pressure monitoring

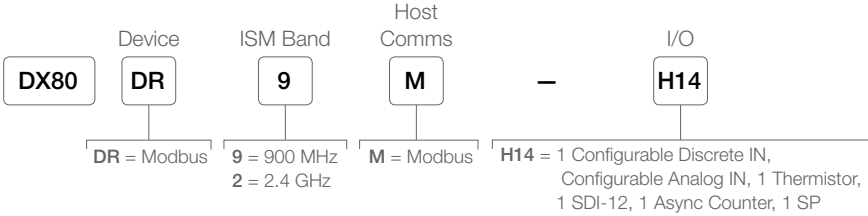

Used with		
T30UX	Long-range ultrasonic sensor	see bannerengineering.com
QT50ULB	Long-range ultrasonic sensor	see bannerengineering.com
M18T	Non-contact temperature sensor	see bannerengineering.com
TL70	Wireless modular tower light	see page 22

DX80 Performance H14 Specifications

Radio Range	900 MHz, 1 Watt: Up to 9.6 km (6 miles)	2.4 GHz, 65 mW: Up to 3.2 km (2 miles)
Minimum Separation Distance	900 MHz, 1 Watt: 4.57 m (15 ft)	2.4 GHz, 65 mW: 0.3 m (1 ft)
Radio Transmit Power	900 MHz, 1 Watt: 30 dBm (1 W) conducted (up to 36 dBm EIRP)	2.4 GHz, 65 mW: 18 dBm (65 mW) conducted, less than or equal to 20 dBm (100 mW) EIRP
Compliance	900 MHz Compliance (1 Watt) FCC ID UE3RM1809: This device complies with FCC Part 15, Subpart C, 15.247 IC: 7044A-RM1809	2.4 GHz Compliance FCC ID UE300DX80-2400 - This device complies with FCC Part 15, Subpart C, 15.247 ETSI/EN: In accordance with EN 300 328: V1.8.1 (2012-04) IC: 7044A-DX8024
Spread Spectrum Technology	FHSS (Frequency Hopping Spread Spectrum)	
Supply Voltage	3.6 V dc low power option from an internal battery	
Current Draw at 3.6 V dc	900 MHz, 1 Watt Approximately 1 mA 900 MHz, 250 mW: Approximately 0.5 mA 2.4 GHz, 65 mW: Approximately 0.3 mA	
Communication Hardware (MultiHop RS-485)	Interface: 2-wire half-duplex RS-485 Baud rates: 9.6k, 19.2k (default), or 38.4k via DIP switches; 1200 and 2400 via the MultiHop Configuration Tool Data format: 8 data bits, no parity, 1 stop bit	
Packet Size (MultiHop)	900 MHz: 175 bytes (85 Modbus registers) 2.4 GHz: 75 bytes (37 Modbus registers)	
Intercharacter Timing (MultiHop)	3.5 milliseconds	
Antenna Connection	Ext. Reverse Polarity SMA, 50 Ohms Max Tightening Torque: 0.45 N-m (4 lbf-in)	
Construction	Polycarbonate housing and rotary dial cover; polyester labels; EDPM rubber cover gasket; nitrile rubber, non-sulphur cured button covers Integrated battery models: Weight: 0.30 kg (0.65 lbs) Non-battery models: Weight: 0.26 kg (0.57 lbs) Mounting: #10 or M5 (SS M5 hardware included) Max. Tightening Torque: 0.56 N-m (5 lbf-in)	
Interface	Indicators: Two bi-color LEDs Buttons: Two Display: Six character LCD	
Wiring Access	Two 1/2-inch NPT	
Operating Conditions	-40 to +85 °C (-40 to +185 °F) (Electronics); -20 to +80 °C (-4 to +176 °F) (LCD) 95% maximum relative humidity (non-condensing) Radiated Immunity: 10 V/m (EN 61000-4-3)	
Shock and Vibration	IEC 68-2-6 and IEC 68-2-27 Shock: 30g, 11 millisecond half sine wave, 18 shocks Vibration: 0.5 mm p-p, 10 to 60 Hz	
Discrete Input	Rating: 3 mA max current at 30 V dc Sample Rate: 40 milliseconds ON Condition (NPN): Less than 0.7 V OFF Condition (NPN): Greater than 2 V or open	
Analog Input	Rating: 24 mA Impedance: Approximately 220 Ohms Sample Rate: 1 second Accuracy: 0.1% of full scale +0.01% per °C Resolution: 12-bit	
Thermistor Input	Model: 44006 or 44031 Series of 10 kOhm thermistors Sample Rate: 1 second Report Rate: 64 seconds Accuracy: 0.4 °C (10 °C to 50 °C); Up to 0.8 °C (-40 °C to 85 °C)	
Counter Input	Event counter: Input rating 1 Hz to 10 kHz (For battery powered devices, the recommended input rating is less than 1 kHz) Rate (frequency) counter: 1 Hz to 10 kHz Threshold: 1.7 V	
Environmental Rating	IEC IP67; NEMA 6	
Certifications		



MultiHop Modbus-H15E

The H15E MultiHop Modbus Data Radio enables users to wirelessly power and control any connected devices and easily monitor device status and performance. It is easy to deploy and a simple way to remotely control lights, fans, motors, and other AC powered devices without the trouble or expense of running cable.

Key Features:

- Switch AC loads up to 10 amps
- AC power field wireable
- No separate power supply required
- Supply voltage of 100 – 277 V AC at 50/60 Hz

Applications:

- Remotely control lights, dimming levels, fans, and motors
- Provide power and control connectivity to remote I/O devices
- Use as an AC powered repeater to extend the range of the wireless network

MultiHop Modbus Radio

Models	I/O	Frequency
DX80DR9M-H15E	Inputs: Two selectable discrete, two 0 to 10 V analog Outputs: Two AC/DC relay (SPDT), two PNP discrete, two 0 to 10 V analog	900 MHz
DX80DR2M-H15E		2.4 GHz

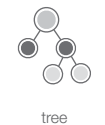
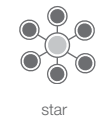

Used with

WLB92ZC1100ACT	Large, ultra-bright LED work light	
WLB32ZC1130QM	Adjustable LED workstation light	see bannerengineering.com
K50LGRYA120Q	50 mm colored domed indicator	

MultiHop -H15E Modbus Radio Specifications

Radio Range	900 MHz, 1 Watt: Up to 9.6 km (6 miles)	2.4 GHz, 65 mW: Up to 3.2 km (2 miles)
Minimum Separation Distance	900 MHz, 150 mW and 250 mW: 2 m (6 ft) 900 MHz, 1 Watt: 4.57 m (15 ft)	2.4 GHz, 65 mW: 0.3 m (1 ft)
Radio Transmit Power	900 MHz, 1 Watt: 30 dBm (1 W) conducted (up to 36 dBm EIRP)	2.4 GHz, 65 mW: 18 dBm (65 mW) conducted, less than or equal to 20 dBm (100 mW) EIRP
Compliance	900 MHz Compliance (1 Watt) FCC ID UE3RM1809: This device complies with FCC Part 15, Subpart C, 15.247 IC: 7044A-RM1809	2.4 GHz Compliance FCC ID UE300DX80-2400 - This device complies with FCC Part 15, Subpart C, 15.247 ETSI/EN: In accordance with EN 300 328: V1.8.1 (2012-04) IC: 7044A-DX8024
Spread Spectrum Technology	FHSS (Frequency Hopping Spread Spectrum)	
Antenna Connection	Ext. Reverse Polarity SMA, 50 Ohms Max Tightening Torque: 0.45 N-m (4 lbf-in)	
Radio Packet Size	900 MHz: 175 bytes (85 Modbus registers)	2.4 GHz: 75 bytes (37 Modbus registers)
Communication Hardware (RS-485)	Interface: 2-wire half-duplex RS-485 Baud rates: 9.6k, 19.2k (default), or 38.4k via DIP switches; 1200 and 2400 via the MultiHop Configuration Tool Data format: 8 data bits, no parity, 1 stop bit	
Link Timeout	Gateway: Configurable via User Configuration Tool (UCT) software Node: Defined by Gateway	
Supply Voltage	Nominal voltage: 120–277 V ac at 60 Hz in North America Nominal voltage: 100–277 V ac at 50/60 Hz outside North America Maximum supply current: 0.37 A Maximum power consumption: 25 W	
Interface	Indicators: Two bi-color LEDs Buttons: Two Display: Six character LCD	
Construction	Polycarbonate housing and rotary dial cover; polyester labels; EDPM rubber cover gasket; nitrile rubber, non-sulphur cured button covers Weight: 0.51 kg (1.13 lbs) Mounting: 1/4-inch or M7 Max. Tightening Torque: 0.56 N-m (5 lbf-in)	
Wiring Access	Two 1/2-inch NPSM ports, 14 threads/inch (1/2-14 NPSM)	
Analog Input	0 to 20 mA Input Rating: 24 mA Impedance: Approximately 100 Ohms Sample Rate: 1 second Accuracy: 0.1% of full scale +0.01% per degree C Resolution: 12-bit	
Output State Following Timeout	De-energized (OFF)	
Relay Outputs	SPDT (Form C) relay 277 V ac, 10 A Minimum Mechanical Life: 10,000,000 Surge breakdown voltage (Between contacts and coil) (Initial): 10,000 V	
Analog Output	0 to 10 V Update Rate: 125 milliseconds Accuracy: 1.0% of full scale +0.01% per °C Resolution: 12-bit	
Shock and Vibration	IEC 68-2-6 and IEC 68-2-27 Shock: 30g, 11 millisecond half sine wave, 18 shocks Vibration: 0.5 mm p-p, 10 to 60 Hz	
Operating Conditions	–40 °C to +85 °C (–40 °F to +185 °F) (Electronics); –20 °C to +80 °C (–4 °F to +176 °F) (LCD) 95% maximum relative humidity (non-condensing) Radiated Immunity: 10 V/m (EN 61000-4-3)	
Environmental Rating	IEC IP65	
Certifications	 	



Intrinsically Safe Nodes

Hazardous area radios are a state-of-the-art combination of wireless communication, battery technology and intrinsically safe electronics. Networks are formed using DX80 Performance Gateways installed beyond the hazardous area and one or more Nodes operating in the same frequency band.

Key Features:

- The DX99 is a state-of-the-art combination of wireless communication, battery technology and intrinsically safe electronics
- All models are certified for operation in Class I, Division 1 and ATEX Zone 0 locations
- Networks formed using DX80 Performance Gateways installed beyond the hazardous area and one or more Nodes operating in the same frequency band
- Both 900 MHz 150 mW and 2.4 GHz 63 mW models are available



Models	I/O	Power Boost	Frequency
DX99N9X1S2N0M2X0D1	Discrete: Two inputs Analog: Two inputs (0-20 mA)	10 V	900 MHz
DX99N9X1S2N0M2X0D2		18 V	
DX99N9X1S2N0V2X0D1	Discrete: Two inputs Analog: Two inputs (0-10 V)	10 V	
DX99N9X1S2N0V2X0D2		18 V	
DX99N2X1S2N0M2X0D1	Discrete: Two inputs Analog: Two inputs (0-20 mA)	10 V	2.4 GHz
DX99N2X1S2N0M2X0D2		18 V	
DX99N2X1S2N0V2X0D1	Discrete: Two inputs Analog: Two inputs (0-10 V)	10 V	
DX99N2X1S2N0V2X0D2		18 V	
DX99N9X1S2N0T4X0D0	Thermocouple: Three inputs, one thermistor input Discrete: Two (NPN) inputs	n/a	900 MHz
DX99N2X1S2N0T4X0D0		n/a	2.4 GHz
DX99N9X1S0N0R4X0D0	RTD: Four inputs	n/a	900 MHz
DX99N2X1S0N0R4X0D0		n/a	2.4 GHz
DX99N9X1S2N0B2X0D0	Bridge: Two inputs Discrete: Two inputs	n/a	900 MHz
DX99N2X1S2N0B2X0D0		n/a	2.4 GHz
DX99N9X1S1S0V2X0D4	Inputs (Modbus Mode): One RS-485 Inputs (Voltage Mode): Two analog, one discrete	13 V	900 MHz
DX99N2X1S1S0V2X0D4			2.4 GHz
DX99N9X1S1N0M3X0D5	Inputs: One analog input with a 29 second warm-up time; one sinking discrete Additional Input Configurations: One 3-wire 100-Ohm Platinum RTD, one sinking discrete, and two analog (0-20 mA)	19 V	900 MHz
DX99N2X1S1N0M3X0D5			2.4 GHz

DX99 FlexPower Node Specifications

Radio Range	900 MHz, 150 mW: Up to 4.8 km (3 miles)	2.4 GHz, 65 mW: Up to 3.2 km (2 miles)
Minimum Separation Distance	900 MHz, 150 mW: 2 m (6 ft)	2.4 GHz, 65 mW: 0.3 m (1 ft)
Radio Transmit Power	900 MHz, 150 mW: 21 dBm (150 mW) conducted	2.4 GHz, 65 mW: 18 dBm (65 mW) conducted, less than or equal to 20 dBm (100 mW) EIRP
Compliance	900 MHz Compliance FCC ID TGUDX80 - This device complies with FCC Part 15, Subpart C, 15.247 IC: 7044A-DX8009	2.4 GHz Compliance FCC ID UE300DX80-2400 - This device complies with FCC Part 15, Subpart C, 15.247 ETSI/EN: In accordance with EN 300 328: V1.8.1 (2012-04) IC: 7044A-DX8024
Spread Spectrum Technology	FHSS (Frequency Hopping Spread Spectrum)	
RS-485 Inputs	Interface: 2-wire half-duplex RS-485 Baud Rates: 9.6k, 19.2k (default), or 38.4k Data Format: 8 data bits, no parity, 1 stop bit (even and odd parity selection are available)	
Communication Hardware (MultiHop RS-485)	Interface: 2-wire half-duplex RS-485 Baud rates: 9.6k, 19.2k (default), or 38.4k via DIP switches; 1200 and 2400 via the MultiHop Configuration Tool Data format: 8 data bits, no parity, 1 stop bit	
Link Timeout	Gateway: Configurable via User Configuration Tool (UCT) software Node: Defined by Gateway	
Supply Voltage	3.6 V dc low power option from an internal battery	
Power Consumption	Consumption: Application dependant	
Housing	Glass and cast aluminium with chromating and chemically-resistant paint (outside only)	
Antenna Connection	Ext. Reverse Polarity SMA, 50 Ohms Max Tightening Torque: 0.45 N-m (4 lbf-in)	
Interface	Indicators: Two bi-color LEDs Buttons: Two Display: Six character LCD	
Wiring Access	Two 1/2-in NPT ports, one 3/4-in NPT port (internal threads)	
Environmental Rating	IEC IP68	
Operating Conditions	-40 °C to +65 °C (-40 °F to +149 °F) (Electronics); -20 °C to +80 °C (-4 °F to +176 °F) (LCD) 95% maximum relative humidity (non-condensing) Radiated Immunity: 10 V/m (EN 61000-4-3)	
Shock and Vibration	IEC 68-2-6 and IEC 68-2-27 Shock: 30g, 11 millisecond half sine wave, 18 shocks Vibration: 0.5 mm p-p, 10 to 60 Hz	

Certifications



CSA: Class I, Division 1, Groups A, B, C, D; Class II, Division 1, Groups E, F, G; Class III, Division 1 (Ex ia IIC T4 / AEx ia IIC T4)
Certificate: 2008243



LCIE/ATEX: Zone 0 (Category 1G) and 20 (Category 1D), Temperature Class T4 (II 1 GD / Ex ia IIC T4/Ex iaD 20 IP68 T82°C)
Certificate: LCIE 08 ATEX 6098 X

Special Conditions for Safe Use imposed by Intrinsic Safety Certificate LCIE 08 ATEX 6098 X:

Ambient temperature range is -40 to 70 °C. Sure Cross® DX99 FlexPower devices can only be connected to Intrinsically Safe certified equipment or simple apparatus as defined by EN 60079-11. All connected equipment must comply with the Entity Parameters (Safety Parameters) listed in the Control Drawings (p/n 141513). The device must only use a lithium battery manufactured by XENO, type XL-205F.

K50 and K30 Hazardous Indicators



Banner's K50 and K30 Indicator Lights for hazardous areas have a smooth 50 or 30 mm diameter dome that provides uniform illumination from all directions.

- Up to three colors in one device and five colors to choose from
- Models rated to IP67 and IP69K for use in harsh environments
- Unique design appears gray when OFF, eliminating false indication from ambient light
- Easy mounting and configuration
- Worldwide IECEx approval for quicker access into countries outside Europe and North America





Accessories

Accessories

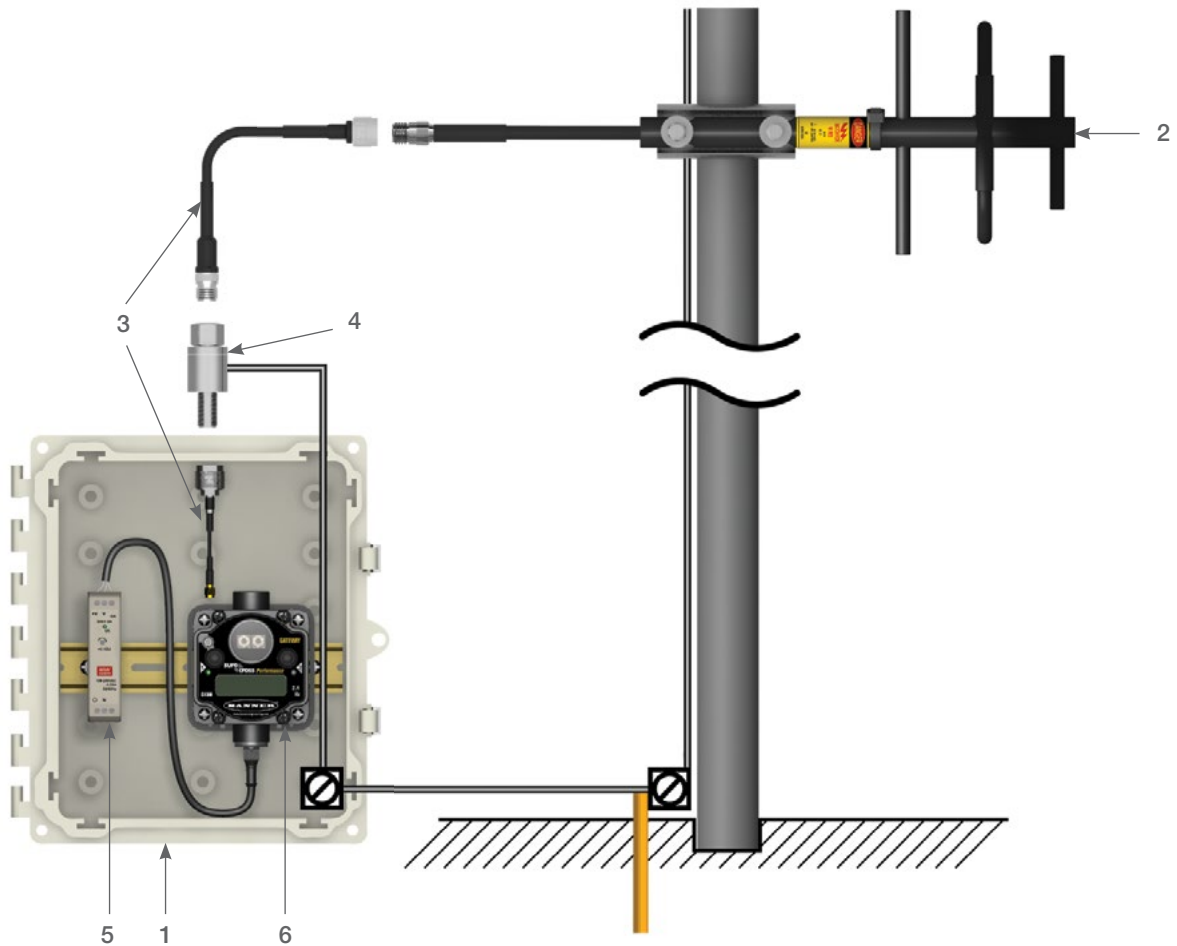

NOTE: The Sure Cross® Radio installation shown includes wireless accessories available from Banner. It is for illustration purposes only. Installations may vary.

(1) Enclosures	71
(2) Antennas	72
(3) Antenna Cables	74
(4) Surge Suppressors	74
(5) Power Supplies.....	75
(6) Brackets	76
Cables.....	78
Cordsets	79
Hardware and Replacement Parts	82
Cable Glands and Plugs	81
Metal Housing Accessories.....	82
Additional Devices and Sensors.....	84
GPS Module.....	85



6 × 6 in:
Fits a single DX80.



10 × 8 in:
Fits a power supply, surge suppressor, a single DX80, and a few relays. This is a popular size but can get cramped.



12 × 10 in:
This is the recommended size; provides ample room for multiple radios and accessories.

(1) Enclosures

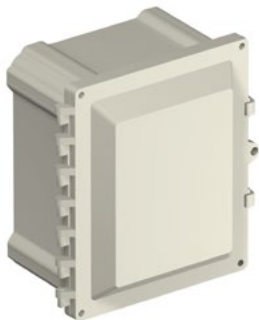

Polycarbonate Enclosures

BWA-AH664	Enclosure, Polycarbonate, with Opaque Cover, 6 × 6 × 4 in
BWA-AH864	Enclosure, Polycarbonate, with Opaque Cover, 8 × 6 × 4 in
BWA-AH1084	Enclosure, Polycarbonate, with Opaque Cover, 10 × 8 × 4 in
BWA-AH12106	Enclosure, Polycarbonate, with Opaque Cover, 12 × 10 × 6 in
BWA-AH14126	Enclosure, Polycarbonate, with Opaque Cover, 14 × 12 × 6 in
BWA-AH16148	Enclosure, Polycarbonate, with Opaque Cover, 16 × 14 × 8 in
BWA-AH181610	Enclosure, Polycarbonate, with Opaque Cover, 18 × 16 × 10 in
BWA-AH664C	Enclosure, Polycarbonate, with Clear Cover, 6 × 6 × 4 in
BWA-AH864C	Enclosure, Polycarbonate, with Clear Cover, 8 × 6 × 4 in
BWA-AH1084C	Enclosure, Polycarbonate, with Clear Cover, 10 × 8 × 4 in
BWA-AH12106C	Enclosure, Polycarbonate, with Clear Cover, 12 × 10 × 6 in
BWA-AH14126C	Enclosure, Polycarbonate, with Clear Cover, 14 × 12 × 6 in
BWA-AH16148C	Enclosure, Polycarbonate, with Clear Cover, 16 × 14 × 8 in
BWA-AH181610C	Enclosure, Polycarbonate, with Clear Cover, 18 × 16 × 10 in

Swing Panel Kits

BWA-AH66SPK	Swing Panel Kit, 6 × 6 in, Includes Mounts, Screws, and Panel
BWA-AH86SPK	Swing Panel Kit, 8 × 6 in, Includes Mounts, Screws, and Panel
BWA-AH108SPK	Swing Panel Kit, 8 × 10 in, Includes Mounts, Screws, and Panel
BWA-AH1210SPK	Swing Panel Kit, 12 × 10 in, Includes Mounts, Screws, and Panel
BWA-AH1412SPK	Swing Panel Kit, 14 × 12 in, Includes Mounts, Screws, and Panel
BWA-AH1614SPK	Swing Panel Kit, 16 × 14 in, Includes Mounts, Screws, and Panel
BWA-AH1816SPK	Swing Panel Kit, 18 × 16 in, Includes Mounts, Screws, and Panel

Back Panel Kits

BWA-BP66A	Back Panel, aluminum, 6 × 6 in
BWA-BP86A	Back Panel, aluminum, 8 × 6 in
BWA-BP108A	Back Panel, aluminum, 8 × 10 in
BWA-BP1210A	Back Panel, aluminum, 12 × 10 in
BWA-BP1412A	Back Panel, aluminum, 14 × 12 in
BWA-BP1614A	Back Panel, aluminum, 16 × 14 in
BWA-BP1816A	Back Panel, aluminum, 18 × 16 in

(1) Enclosures, continued

DIN Rail Kits (with self-threading screws)

BWA-AH6DR	Din Rail Kit 6 in (Includes 2 Tribolar Screws and DIN Rail)
BWA-AH8DR	Din Rail Kit 8 in (Includes 2 Tribolar Screws and DIN Rail)
BWA-AH10DR	Din Rail Kit 10 in (Includes 2 Tribolar Screws and DIN Rail)
BWA-AH12DR	Din Rail Kit 12 in (Includes 2 Tribolar Screws and DIN Rail)
BWA-AH14DR	Din Rail Kit 14 in (Includes 2 Tribolar Screws and DIN Rail)
BWA-AH16DR	Din Rail Kit 16 in (Includes 2 Tribolar Screws and DIN Rail)
BWA-AH18DR	Din Rail Kit 18 in (Includes 2 Tribolar Screws and DIN Rail)

Enclosure Accessories

BWA-AHAK	Accessory Kit, Includes all screws, inserts, and mounting feet (Replacement Only)
-----------------	---



Fiberglass Enclosures

BWA-EF1086	Enclosure Fiberglass Hinged 10 × 8 × 6 in
BWA-EF866	Enclosure Fiberglass Hinged 8 × 6 × 6 in
BWA-PANEL108	Panel, 10 × 8 in
BWA-PANEL86	Panel, 8 × 6 in

(2) Antennas

Select your antenna based on your specific application needs. There are three basic antenna solutions:

- Use the supplied rubber duck antenna inside the enclosure. DX80 products come with a 2 dBi rubber duck antenna. Often simply attaching the supplied antenna to the radio provides enough radio range to meet your needs.
- Mount a dome antenna to the enclosure. The -D antennas can be mounted directly on the enclosure.
- Use an N-type pole-mounted antenna, with surge suppressor. The -A and -AS antennas can be mounted remotely from the enclosure and require the BWC-LFNBMN-DC surge suppressor.



Omni-Directional Antennas with RP-SMA Male Connections

BWA-902-C	900 MHz	2 dBi, Rubber swivel (ships with 900 MHz radios)
BWA-905-C		5 dBi, Rubber swivel
BWA-202-C		2 dBi, Rubber swivel, 3 1/4 in (ships with 2.4 GHz radios)
BWA-205-C	2.4 GHz	5 dBi, Rubber swivel, 6 1/2 in
BWA-207-C		7 dBi, Rubber swivel, 9 1/4 in
BWA-902-RA	900 MHz	2 dBi, Rubber fixed right-angle
BWA-902-RA2	900 MHz	2 dBi 1/2 wave, Rubber fixed right-angle, 160 mm tall
BWA-201-001	2.4 GHz	1 dBi, Rubber, 1 in tall

(2) Antennas, continued



Omni-Directional Dome Antennas

BWA-902-D	900 MHz	2 dBi, 18 inch cable	RP-SMA Box Mount
BWA-202-D	2.4 GHz	2 dBi, 18 inch cable	RP-SMA Box Mount

Other



BWA-205-M	2.4 GHz	5 dBi, Magnetic whip antenna, 12 ft cable	RP-SMA Male
-----------	---------	---	-------------

Omni-Directional Fiberglass Antennas with N-Type Female Connections



BWA-906-A	900 MHz	2 dBi, Rubber swivel (ships with 900 MHz radios)
BWA-208-A	2.4 GHz	8.5 dBi, Fiberglass, 24 in
BWA-206-A		6 dBi, Fiberglass, 16 in (shown)
BWA-906-AS	900 MHz	6 dBi, Fiberglass, 1/4 Wave, 23.6 in (1.3 inch diameter)
BWA-908-AS		8 dBi, Fiberglass, 3/4 Wave, 63 in (1.5 inch diameter)

Directional (Yagi) Antennas with N-Type Female Connection



BWA-9Y6-A	900 MHz	6.5 dBd, 6.8 x 13 inches Outdoor
BWA-9Y10-A	900 MHz	10 dBd, 6.8 x 24 inches Outdoor

Cellular (CDMA multi band)

BWA-CDMA-002	RP-SMA male connection	2 dBi, 6.3 in blade style
--------------	------------------------	---------------------------

(3) Antenna Cables



Antenna Cables: RP-SMA to RP-SMA

BWC-1MRSFRSB0.2	RG58, RP-SMA Male to RP-SMA Female Bulkhead, 0.2 m
BWC-1MRSFRSB1	RG58, RP-SMA Male to RP-SMA Female Bulkhead, 1 m
BWC-1MRSFRSB2	RG58, RP-SMA Male to RP-SMA Female Bulkhead, 2 m
BWC-1MRSFRSB4	RG58, RP-SMA Male to RP-SMA Female Bulkhead, 4 m
BWC-2MRSFRS3	LMR200, RP-SMA Male to RP-SMA Female, 3 m
BWC-2MRSFRS6	LMR200, RP-SMA Male to RP-SMA Female, 6 m
BWC-2MRSFRS9	LMR200, RP-SMA Male to RP-SMA Female, 9 m
BWC-2MRSFRS12	LMR200, RP-SMA Male to RP-SMA Female, 12 m

Antenna Cables: RP-SMA to N-Type



BWC-1MRSMN05	LMR100 RP-SMA to N-Type Male, 0.5 m
---------------------	-------------------------------------

BWC-1MRSMN2 LMR100 RP-SMA to N-Type Male, 2 m

Antenna Cables: N-Type



BWC-4MNFN3	LMR400 N-Type Male to N-Type Female, 3 m
BWC-4MNFN6	LMR400 N-Type Male to N-Type Female, 6 m
BWC-4MNFN15	LMR400 N-Type Male to N-Type Female, 15 m
BWC-4MNFN30	LMR400 N-Type Male to N-Type Female, 30 m

(4) Surge Suppressors



BWC-LFNBMN-DC	Surge Suppressor, bulkhead, N-Type Female, N-Type Male, dc Blocking
----------------------	---

BWC-LMRSFRPB Surge Suppressor, bulkhead, RPSMA to RP-SMA

(5) Power Supplies

DC Power Supplies



PSW-24-1	DC Power Supply, 100-240 V ac 50/60 Hz input, 24 V dc 1 A output, UL Listed Class 2
PSD-24-4	DC Power Supply, 90-264 V ac 50/60 Hz input, 24 V dc output, US-style wall plug input, 4-pin M12/Euro-style output; 2 m (6 ft) cable, UL Listed Class 2
PSDINP-24-06	DC Power Supply, 0.63 Amps, 24 V dc, with DIN Rail Mount, Class I Division 2 (Groups A, B, C, D) Rated
PSDINP-24-13	DC Power Supply, 1.3 Amps, 24 V dc, with DIN Rail Mount, Class I Division 2 (Groups A, B, C, D) Rated
PSDINP-24-25	DC Power Supply, 2.5 Amps, 24 V dc, with DIN Rail Mount, Class I Division 2 (Groups A, B, C, D) Rated

FlexPower Supplies and Replacement Batteries



DX81-LITH	Battery Supply Module with mounting hardware
DX81H	Battery Supply Module with mounting hardware, for DX99 polycarbonate housing

DX81P6 Battery Supply Module, six "D" cells, with mounting hardware

Solar Panels



BWA-SOLAR PANEL 3W	Solar Panel, 12 V, 3 W, Multicrystalline, 188 × 195 × 15, Wall/ Pole clamp style mounting bracket included
BWA-SOLAR PANEL 5W	Solar Panel, 12 V, 5 W, Multicrystalline, 270 × 222 × 17, Wall/ Pole clamp style mounting bracket included
BWA-SOLAR PANEL 20W	Solar Panel, 12 V, 20 W, Multicrystalline, 573 × 357 × 30, "L" mounting bracket included
BWA-SOLAR CNTRL-12V	Solar Controller, 6 A Load Current 12 V System Voltage, recommended for 20 watts or less solar panel AND Sealed Lead Acid Battery (SLA)

(5) Power Supplies, continued



Replacement Batteries

BWA-BATT-001	Lithium "D" cell, single, for DX81-LITH and DX81H Battery Supply Module
BWA-BATT-006	Lithium "AA" cell, single, for Wireless Q45 Sensors for DX81x models



Relays

IB6RP	Interface Relay Box, 18 to 26 V dc inputs, isolated relay outputs (not shown)
BWA-RELAY-12V	Relay, Blade Style with Base, 12 V
BWA-RELAY-24V	Relay, Blade Style with Base, 24 V
BWA-RH1B-UDC12V	Relay, Blade Style, No Base, 12 V (replacement part)
BWA-RH1B-UDC24V	Relay, Blade Style, No Base, 24 V (replacement part)
BWA-SH1B-05	Relay Base Only (replacement part)

(6) Brackets and Mounting Options

Mounting Kit

BWA-HW-001	<ul style="list-style-type: none"> Screw, M5-0.8 x 25 mm, SS (4) Screw, M5-0.8 x 16 mm, SS (4) Hex nut, M5-0.8 mm, SS (4) Bolt, #8-32 x 3/4-in, SS (4)
------------	--

Brackets



SMBDX80DIN	<ul style="list-style-type: none"> Black reinforced thermoplastic bracket for mounting on a 35 mm DIN rail
------------	---



BWA-HW-034	<ul style="list-style-type: none"> DIN rail clip, black plastic Used with the M-HBx MultiHop and -PBx Performance board modules
------------	---



SMBAMS18RA	<ul style="list-style-type: none"> Right-angle SMBAMS series bracket with 18 mm hole Articulation slots for 90+° rotation 12-ga. (2.6 mm) cold-rolled steel
------------	--

Hole center spacing: A = 26.0, A to B = 13.0
 Hole size: A = 26.8 x 7.0, B = ø 6.5, C = ø 19.0

BWA-BK-001	<ul style="list-style-type: none"> • Use to mount vibration sensor models QM42VT1 and QM42VT2 • Includes magnetic mounting bracket SMB42FLM12 and 2 mounting screws
-------------------	---

BWA-BK-004 • Mounts both the K50U Ultrasonic sensor and a Wireless Q45U Node or DX80 Node

BWA-BK-005	<ul style="list-style-type: none"> • Mounts both the K50U Ultrasonic sensor and a Wireless Q45U Node
-------------------	---

BWA-BK-008 • QM42 Center-mount magnetic bracket for round objects

BWA-HW-057	<ul style="list-style-type: none"> • 3M™ Thermally Conductive Adhesive Transfer Tape 8820 • Provides a heat-transfer path between heat-generating components and heat sinks or other cooling devices • 3 pieces per pack • Tape is 20 mils (0.50 mm) thick; liner is 1.5-2 mil (37.5-50 µm) thick • Thermally conductive ceramic filler • Dual liner using silicone-treated polyester: easy-release PET
-------------------	---



Hole center spacing: 35.1
Hole size: 25.4 x 5.3

DIN-35-70 = 70 mm
DIN-35-105 = 105 mm
DIN-35-140 = 140 mm

- 35 mm DIN Rail

Ethernet Cables

Use a crossover cable to connect the GatewayPro or DX83 Ethernet Bridge to a host system without using an Ethernet switchbox or hub. When using a switchbox or hub, use a straight cable.

BWA-E2M	Ethernet cable, RSCD RJ45 440, 2 m
BWA-E8M	Ethernet cable, RSCD RJ45 440, 8 m
BWA-EX2M	Ethernet cable, crossover, RSCD RJ45CR 440, 2 m



Adaptor Cables

BWA-HW-006	Adapter cable, USB to RS-485, for use with the User Configuration Tool software (UCT)
BWA-UCT-900 (shown)	Adapter cable with power, USB to RS-485, for use with the User Configuration Tool software (UCT), supplies power to 1 Watt radios
BWA-USB1WIRE-01	PC USB to 1-wire Serial Interface converter. Use with the Sensor Configuration Tool software to communicate directly with 1-wire Serial Interface sensors

Splitter Cables

Use **CSRB-M1250M125.47M125.73** to split power between two *FlexPower*® or solar powered devices. DO NOT use this cable to connect a *FlexPower* devices to a 10 to 30 V dc powered device.

Use **CSRB-M1253.28M1253.28M1253.28** to connect one *FlexPower* device (data radio, FlexPowered Gateway, etc) to two power sources, such as the *FlexPower* Solar Supply and DX81P6 Battery Pack.

Model	Length	Style	Pinout
CSRB-M1250M125.47M125.73	Trunk: 0 m (male) Branches: 0.14 m and 0.22 m (female)	Straight	<div style="display: flex; justify-content: space-around;"> <div style="text-align: center;"> <p>Male</p> </div> <div style="text-align: center;"> <p>Female</p> </div> </div> <p>1 = Brown 2 = White 3 = Blue 4 = Black 5 = Green/Yellow</p>
CSRB-M1253.28M1253.28M1253.28	Trunk: 1 m (female) Branches: 1 m (male)		

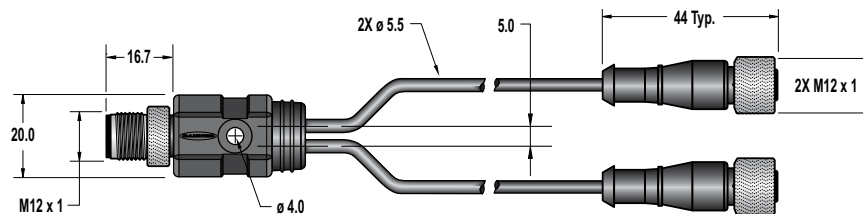

Model	Branches	Trunk	Pinout
CSB-M1240M1240	No branch	No trunk	<p>Female Female</p> <p>1 = Brown 2 = White 3 = Blue 4 = Black 5 = Gray</p>
CSB-M1240M1241	2 x 0.30 m (1 ft)	No trunk	
CSB-M1241M1241	2 x 0.30 m (1 ft)	0.30 m (1 ft)	
CSB-M1248M1241		2.50 m (8 ft)	
CSB-M12415M1241		4.57 m (15 ft)	
CSB-M21425M1241	2 x 0.30 m (1 ft)	7.60 m (25 ft)	
CSB-UMT425M1241		7.60 m (25 ft) Unterminated	

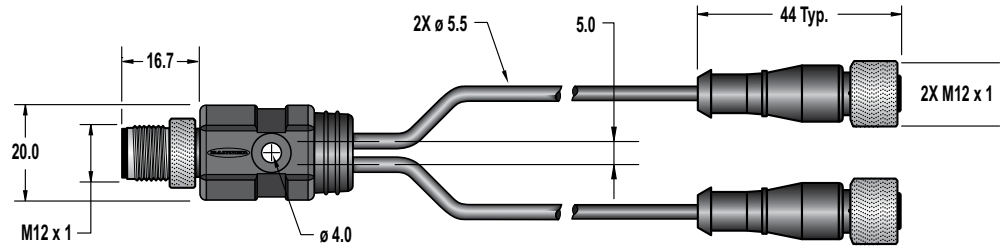

Cordsets

Euro-Style — Single-Ended

Right-angle cordsets are not compatible with the DX70 devices. When facing the Node or Gateway toward you and the quick-disconnect connection is facing down, the right-angle cables exit to the right.

When using the *FlexPower*® Node with integrated battery, use a double-ended cordset. When using a *FlexPower* Node with external power supply, use a single-ended cordset. If using the communication lines, the cable length cannot exceed 3 meters (10 ft).

Model	Length	Style	Dimensions	Pinout
MQDC1-501.5	0.50 m (1.5 ft)	Straight		<p>Female</p> <p>1 = Brown 2 = White 3 = Blue 4 = Black 5 = Gray</p>
MQDC1-506	1.83 m (6 ft)			
MQDC1-515	4.57 m (15 ft)			
MQDC1-530	9.14 m (30 ft)			
MQDC1-506RA	1.83 m (6 ft)	Right-Angle		
MQDC1-515RA	4.57 m (15 ft)			
MQDC1-530RA	9.14 m (30 ft)			

Cordsets, continued

Model	Length	Style	Description
BWA-QD5.5	—	—	Prewired 5-pin Euro connector, 1/2-14 NBSM
BWA-QD8.5	—	—	Prewired, 8-pin Euro connector, 1/2-14 NBSM
BWA-QD12.5	—	—	Prewired 12-pin Euro connector, 1/2-14 NBSM
FIC-M12F4	—	Straight	Euro-Style Field-Wireable Connector 4-pin Female Straight
MQDMC-401	0.5 m	Straight	Cordset, 4-pin Euro-style, single ended, male, longer pigtails for DX80...C models

Euro-Style — Double-Ended

When using the *FlexPower*® Node with integrated battery, use a double-ended cordset. When using a *FlexPower* Node with external power supply, use a single-ended cordset. If using the communication lines, the cable length cannot exceed 3 meters (10 feet).

Model	Length	Style	Dimensions	Pinout
DEE2R-51D	0.31 m (1 ft)	Female Straight/ Male Straight		<p>Male</p> <p>Female</p> <p>1 = Brown 2 = White 3 = Blue 4 = Black 5 = Green/Yellow</p>
DEE2R-53D	0.91 m (3 ft)			
DEE2R-58D	2.44 m (8 ft)			

Other Cordsets

BWA-RIBBON-001	Ribbon cable, 20-pin DBL socket
----------------	---------------------------------

BWA-HW-010 Cable, *FlexPower* Current Monitoring

DX85 Modbus RTU Remote I/O Devices



IP67 Housing



IP20 Housing

Model	Description
DX85M6P6	DX85 Modbus RTU Remote I/O, 6 Discrete IN, 6 Discrete OUT
DX85M4P4M2M2	DX85 Modbus RTU Remote I/O, 4 Discrete IN, 4 Discrete OUT, 2 Analog IN, 2 Analog OUT (0 to 20 mA)
DX85M4P8	DX85 Modbus RTU Remote I/O, 4 Discrete IN, 8 Discrete OUT
DX85M8P4	DX85 Modbus RTU Remote I/O, 8 Discrete IN, 4 Discrete OUT
DX85M0P0M4M4	DX85 Modbus RTU Remote I/O, 4 Analog IN, 4 Analog OUT (0 to 20 mA)
DX85M-P7	DX85 Modbus RTU Remote I/O, Up to 12 sinking inputs or up to 12 NMOS sinking outputs (for a total of 12 I/O)
DX85M-P8	DX85 Modbus RTU Remote I/O, Up to 12 sourcing inputs or up to 12 sourcing outputs (for a total of 12 I/O)

NOTE: Add a "C" to the end of any DX85 model to order that I/O mix with an IP20 housing. The IP20 models are Class I, Division 2 certified when installed in a suitable enclosure.

Cable Glands and Plugs

Model	Description
BWA-HP.5-10	Dummy Hole Plugs, 1/2-in NPT, 10 pieces
BWA-HW-031	Vent Plug, 1/2-in NPT, IP67
BWA-HW-059	Vent Plug, Plastic, 1/2-inch NPT, Strain-relief fitting, with o-ring, for 0.2 to 0.35 dia cable
BWA-HW-053	Plug Conduit, Plastic Hex, 1/2-14 NPT, for 1.2 to 2.5 mm dia
BWA-HW-052	Cable Gland Pack: 1/2-inch NPT gland, 1/2-inch NPT multi-cable gland, and 1/2-inch NPT vent plug
BWA-CG.5-10	Cable Glands, 1/2-in NPT, Cordgrip for 3 holes of 2.8 to 5.6 mm diameter, 10 Pack
BWA-CG.5-3X5.6-10	Cable Glands, 1/2-inch NPT, Cordgrip for 3 holes of 2.8 to 5.6 mm diam, 10 Pack
BWA-CG.5-2X2.5-10	Cable Glands, 1/2-in NPT, Cordgrip for 2 holes of 1.2 to 2.5 mm diameter, 10 Pack
BWA-CG.5-6X4.0-10	Cable Glands, 1/2-in NPT, Cordgrip for 6 holes of 2 to 4 mm diameter, 10 Pack
BWA-CG.5-6X3.0-10	Cable Glands, 1/2-in NPT, Cordgrip for 6 holes of 1.5 to 3 mm diameter, 10 Pack

Hardware and Replacement Parts

Model	Description
BWA-HW-002	DX80 Access Hardware Kit: Plastic threaded plugs, PG-7 (4) Nylon gland fittings, PG-7 (4) Hex nuts, PG-7 (4) Plug, 1/2-in NPT Nylon gland fitting, 1/2-in NPT
BWA-HW-003	PTFE Tape, 1/4-in wide, 600-in long
BWA-HW-004	Replacement Seals: O-ring, rotary access cover, PG21 (2) O-ring, body gasket (2) Access cover, rotary dials, clear plastic (2)
BWA-HW-009	Solar assembly hardware pack, includes brackets, bolts, and set screws
BWA-HW-007	Housing Kit, DX80, top and bottom, 10 pieces
BWA-HW-008	Housing Kit, DX81, top and bottom, 10 pieces
BWA-HW-044	Terminal header for the MultiHop Ethernet Data Radio
BWA-HW-011	Terminal Block Headers, IP20, 2 pack
BWA-HW-012	DX99 Antenna Extension Pack: Screw, M4-0.7 x 20, pan head, black steel Flexible Antenna Cable, 12 in, SMA male to SMA female
BWA-HW-032	Access hardware for the E housing, one 1/2-in plug, one 1/2-in gland
BWA-HW-037	Clear plastic retaining ring for DX99 metal housings, 10 pack

Metal Housing Accessories



Model	Description
BWA-HW-016	Antenna Feedthrough, Stainless Steel, 1/2-in NPT
BWA-HW-017	Antenna Feedthrough, Stainless Steel, 3/4-in NPT
BWA-HW-012	DX99 Antenna Extension Pack (M4-0.7 x 20 black steel pan head screw, flexible antenna cable 12-in SMA male to SMA female)
BWA-HW-037	Clear plastic retaining ring for DX99 metal housings (10 pack)
BWA-AXFS0130	AXF™ Explosion-Proof Antenna Coupler



Omni-Directional Dome Antennas

Models	Frequency	Description	Connection
BWA-902-001	900 MHz	2 dBi, 18 inch cable	1/2-in SS NPT Port
BWA-902-002			3/4-in SS NPT Port
BWA-202-001	2.4 GHz		1/2-in SS NPT Port
BWA-202-002			3/4-in SS NPT Port



Additional Devices and Sensors

DX85 Modbus RTU Remote I/O Devices

These remote I/O devices have a Modbus Interface and are used to expand the I/O of the Gateway or the Modbus host.



IP67 Housing



IP20 Housing

Models	I/O
DX85M6P6	DX85 Modbus RTU Remote I/O, 6 Discrete IN, 6 Discrete OUT
DX85M4P4M2M2	DX85 Modbus RTU Remote I/O, 4 Discrete IN, 4 Discrete OUT, 2 Analog IN, 2 Analog OUT (0 to 20 mA)
DX85M4P8	DX85 Modbus RTU Remote I/O, 4 Discrete IN, 8 Discrete OUT
DX85M8P4	DX85 Modbus RTU Remote I/O, 8 Discrete IN, 4 Discrete OUT
DX85M0P0M4M4	DX85 Modbus RTU Remote I/O, 4 Analog IN, 4 Analog OUT (0 to 20 mA)
DX85M-P7	DX85 Modbus RTU Remote I/O, Up to 12 sinking inputs or up to 12 NMOS sinking outputs (for a total of 12 I/O)
DX85M-P8	DX85 Modbus RTU Remote I/O, Up to 12 sourcing inputs or up to 12 sourcing outputs (for a total of 12 I/O)

NOTE: Add a "C" to the end of any DX85 model to order the I/O mix with an IP20 housing. The IP20 models are Class I, Division 2 certified when installed in a suitable enclosure.

Sensors Optimized for Use with FlexPower® Devices

Models	I/O
SM312LPQD-78447	MINI-BEAM®, Low Power, 5 V, polarized retroreflective, 3 m
SM312DQD-78419	MINI-BEAM®, Low Power, 5 V, diffuse, 38 cm
QT50ULBQ6-75390	Ultrasonic, QT50U, 200 mm to 8 m range
QS30WEQ	WORLD-BEAM® Photoelectric Emitter, QS30 (Max Range: 100 ft, 10x excess gain at 50 ft), 1-wire Serial Interface
QS30WRQ	WORLD-BEAM® Photoelectric Receiver, QS30 (Max Range: 100 ft, 10x excess gain at 50 ft), 1-wire Serial Interface





GPS50M GPS Module

Low power consumption, ability to withstand harsh environments, flexible power supply requirements and Modbus RTU communications makes this module ideal for the industrial market.

- Self-contained GPS Module for industrial use.
- Flexible Power Requirements: 5 to 30 V dc with power consumption as low as 100 mW
- Positional error of less than 2.5 meters
- Self-contained for harsh environment; IP69K-rated

GPS50M GPS Module Specifications

Power Requirements	5 to 30 V dc	
Current	Maximum: < 0.5 W Power Save Mode ON Typ. Average: 4 mA at 24 V dc Power Save Mode OFF Tye. Average: 10 mA at 24 V dc	
Indicators	Green flashing: Power ON	Amber flashing: Modbus communication active
Indicators	Green flashing: Power ON	Red flicker: Serial Tx
Operating Temperature	-40 to +85 °C (-40 to +185 °F)	
GPS Features	<ul style="list-style-type: none"> • SIRF Star IV GPS chip • Satellite-based augmentation systems: WAAS, EGNOS, MSAS, GAGAN 	<ul style="list-style-type: none"> • High sensitivity navigation engine (PVT) tracks as low as -163 dBm • Update Rate: 1 Hz
Communication	<ul style="list-style-type: none"> • Interface: RS-485 Serial • Baud rates: 9.6k, 19.2k (default), or 38.4k • Data format: 8 data bits, no parity (default), 1 stop bit (even or odd parity available) 	<ul style="list-style-type: none"> • Do not use termination resistor • Protocol: Modbus RTU
Shock and Vibration	<ul style="list-style-type: none"> • IEC 68-2-6 and IEC 68-2-27 • Shock: 30g, 11 millisecond half wave, 18 shocks • Vibration: 0.5 mm p-p, 10 to 60 Hz 	
Accuracy	<ul style="list-style-type: none"> • Positional error of less than 2.5 m (8') with augmentation • Positional error of less than 10 m (33') with no augmentation 	

Other Sensors or Sensor Components

Models	I/O
BWA-THERM-PROBE-001	Temperature sensor with thermistor PS103G2 Operating Temperature Range -20 °C to +105 °C Maximum Power Rating 30 mW Accuracy +/- 0.2%; Plated nickel finish
BWA-S612-30-100	NoShok Series 612 Submersible Level Transmitter, model 612-30-1-1-N-100, 0 to 30 psig, 100' cable
BWA-S612-15-100	NoShok Series 612 Submersible Level Transmitter, model 612-15-1-1-N-100, 0 to 15 psig, 100' cable
BWA-625-5000-1-1-8-25	NoShok Series 625 Intrinsically Safe Pressure Transmitter, model 625-5000-1-1-8-25, 0 to 5000 psig, 1/2-in NPT, 4-20mA, M12 QD
BWA-625-10000-1-1-8-25	NoShok Series 625 Intrinsically Safe Pressure Transmitter, model 625-10000-1-1-8-25, 0 to 10000 psig, 1/2-in NPT, 4-20mA, M12 QD
BWA-P-RKGV 5.33T-1727-2.0	Cable, female M12 4-pin, blue PVC, SS connector, for NoShok Series 625 IS Pressure Transmitter
BWA-ACC-SEN-SDI	Acclima SDI-12 Soil Moisture Transducer

Reference



Data Security

Binding the radios in a network (similar to pairing a phone to a headset, but more secure) locks them to a specific master radio by teaching them the master radio's access code. After the devices are bound, the radios only accept data from that master radio and the master radio only accepts data from the radios that are bound to it.

The proprietary protocol used in Banner's wireless networks provides a high level of data security.

A pseudo-random frequency hopping table is used to provide noise immunity and data security. Each time a message is sent a new frequency is chosen, which makes it almost impossible for any system listening at a given time to hear more than a few messages out of hundreds.

Generic data transfer without context also keeps data secure. Even if a hacker managed to crack the data packet format, all they would see is a set of 16-bit numbers with no reference as to what the numbers mean.



Deterministic System

Determinism is the ability to predict and control network behavior by establishing default states for specific conditions. Banner's deterministic system defines how network endpoints behave during the loss of communications. The network identifies when the communications link is lost and sets relevant outputs to user defined conditions. Once the radio signal is reestablished, the network returns to normal operations.

Example: If a tank level sensor is being used to turn a pump on to refill the tank, the deterministic system will allow you to set the default output state as "OFF" if the wireless signal is lost. With the output set at "OFF", the pump will not be able to over fill the tank in the event of a loss of communications.



Frequency

Banner's wireless products operate in the license free ISM band with products that operate at the 900 MHz and 2.4 GHz frequencies.

- 2.4 GHz radios transmit data packets faster and require less power. They are primarily used outside North America.
- 900 MHz radios have a longer range and a better ability to penetrate walls and other obstacles. It is typically used in North America.



Frequency Hopping Spread Spectrum (FHSS)

Frequency Hopping Spread Spectrum is a radio communication technology where the frequency spectrum is divided into channels. Data packets are split up and transmitted on these channels in a random pattern known only to the transmitter and receiver (e.g., Gateway and Node). Because colocated networks follow different random patterns, or hop code tables, multiple networks can operate in close proximity without interfering. If interference is present on one channel, data transmission is blocked. The transmitter and receiver hop to the next channel in the hop table and the transmitter resends the data packet.

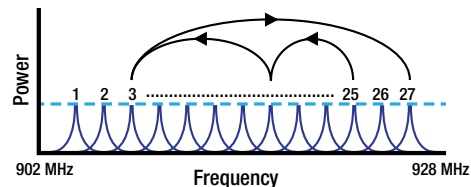

Intrinsically Safe

The Sure Cross® DX99 product line is classified as intrinsically safe (IS), not explosion proof, and is certified for a variety of hazardous locations. Intrinsically safe products limit electrical and thermal energy to levels below that required to ignite a flammable or combustible atmospheric mixture in hazardous areas. Each product's datasheet lists the specific certifications for that product.



Network Interference

The Banner wireless system can be installed within any existing 802.11b (Wi-Fi) environment. The low data rates and narrow frequency band of the Banner wireless system make it essentially silent to existing Wi-Fi networks. Additionally, Banner's Gateways and Nodes exchange a binding code that prevents radios outside the network from communicating with it. Finally, they also use multiple frequency hops to eliminate data collisions.



Network Security

The Banner wireless systems use a proprietary protocol and are designed to completely eliminate all Internet Protocol (IP) based security threats. Open protocols, such as Wi-Fi, can route malicious TCP/IP packets that can cause security breaches; however, the Banner wireless systems can not. The Banner protocol only carries sensor data values. It is not possible to gain access to the organization's main network through the Sure Cross wireless system and it is not possible to receive a web page or executable file over the wireless communication layer. Only I/O data is transmitted in the Banner wireless network.

Network Topologies



Point-to-Point

The most basic form of a radio network is called point-to-point. As the name implies, there are only two radios in this network, one Gateway and one Node.



Point-to-Multipoint

Point-to-multipoint is a relatively simple network with one Gateway and a few Nodes. Banner's PM Series is preconfigured to handle up to six Nodes.



Star

This network is formed by connecting multiple Nodes to a single Gateway. The Gateway maintains a communications connection with each Node on a separate communications path. If the communication between one of the Nodes and the gateway fails, the rest of the network remains unaffected.



Tree

This network involves several slaves that transmit information to repeaters, which ultimately transmit to the master radio. The use of repeaters can greatly extend the range of the network. This network must have a host controller that controls the master radio.



Network Scalability

Banner's Simple Wire Replacement products come preconfigured to handle up to 6 Nodes (PM8) so that it is easy to set up your network without software. The DX80 Performance Series offers Gateways that support multiple host communication protocols and up to 47 Nodes. Data Radios can handle up to 50 slave radios, and MultiHop Radios can handle up to 100 slave radios.

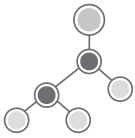

MultiHop

A MultiHop network uses repeaters to extend the range of the network with multiple “hops” to cover longer distances or to circumvent obstacles (trees, buildings, topology, etc.). MultiHop networks are also self-forming (all radios added to the network will automatically connect to the master or a repeater within its range) and self-healing (if a repeater is removed from the network, the radios connected to it can find a new path back to the master radio).

At the root of the MultiHop network is the master radio. All radios within range of the master (whether slave or repeater) connect to it. The master serves as the parent (controls the timing of the network), repeaters and slaves connect as children.

MultiHop Master Radio: Within a MultiHop network, there is only one master radio. It controls the overall timing of the network and is always the parent device. The master radio must be controlled by a host system.

MultiHop Repeater Radio: The repeater acts as a child to the master radio and a parent a slave radio. It retransmits data packets between the master radio and slave radios.

MultiHop Slave Radio: The slave radio is the end device of the network. A radio in slave mode does not retransmit data packets on the radio link.

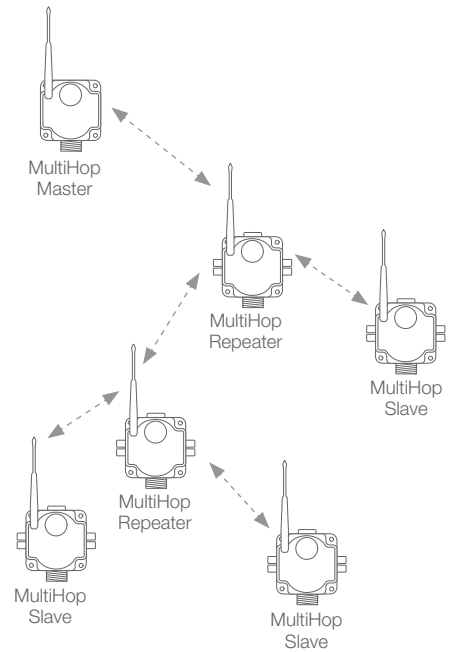

Radio Range

Banner’s wireless network is designed for long distance applications. The signal for 900 MHz, 1 Watt radios will travel up to 6 miles and 2.4 GHz, 65 mW radios will travel up to 2 miles line-of-sight.

Line-of-sight is the unobstructed path between radio antennas; however, signals can penetrate walls, floors and other indoor obstructions. Buildings, trees and large metal objects will impact signal strength in outdoor applications.

To verify range, Banner integrates a site survey tool into each Gateway and Node that displays real time signal quality results. Always conduct a site survey prior to installing a wireless network.

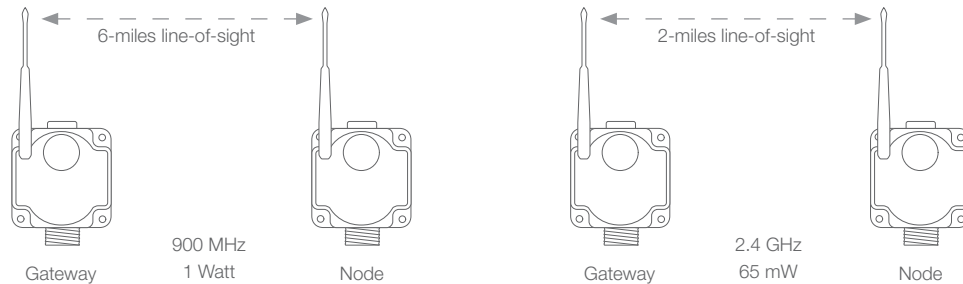

TDMA

Time Division Multiple Access (TDMA)

TDMA provides a specific communication time slot for each device in the network, eliminating data collisions. The master radio “requests” data from each node during its time slot, and the node then sends the data. A TDMA architecture also lends itself to efficient power management procedures. When each device knows the time period to receive or send, the radio doesn’t have to ‘listen’ all the time. Power usage can be managed efficiently, allowing radio devices to operate from 3.6 V lithium batteries when necessary.



How to Reach Us

Global Sales and Support

Questions? Need additional assistance?

Banner has more than 3,000 representatives and distributors worldwide — ready to help you. Our highly skilled application engineers and industry experts are ready to support you wherever you are. For a complete listing, go to bannerengineering.com and find your local Banner Representative.

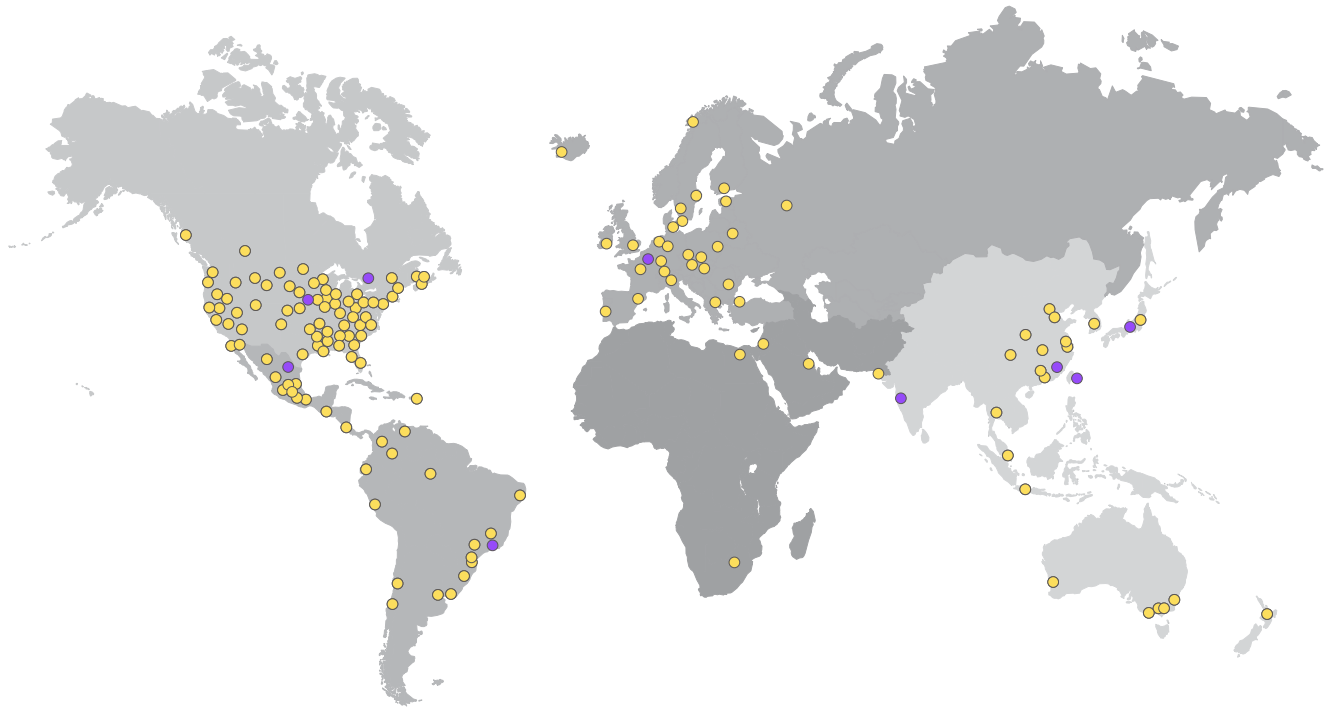

To contact a Banner Engineer about your application, call 1-888-3SENSOR (1-888-373-6767) or visit our website at www.bannerengineering.com/contact-us





Banner Engineering Corp.

9714 Tenth Avenue North • Minneapolis, Minnesota 55441
763-544-3164 • 1-888-373-6767

www.bannerengineering.com